

A-A' WALL BASE	H-H' OUTSIDE CORNER
B-B' HORIZONTAL JOINT	I-I' DOOR HEAD
C-C' VERTICAL JOINT	J-J' DOOR JAMB
D-D' WINDOW SILL	K-K' WALL / CEILING INTERSECTION
E-E' WINDOW JAMB	L-L' CEILING / WALL INTERSECTION
F-F' WINDOW HEAD	M-M' WALL / CEILING INTERSECTION
G-G' INSIDE CORNER	N-N' CEILING / WALL INTERSECTION

**Measurements in inches are approximated. Real measurements in mm.**

The updated version of this present installation detail can be found on the PARKLEX PRODEMA web.  
Panel sizes and maximum distances in technical catalogue.

FIXING DETAIL

MEASURES: INCH & MM

**PARKLEX PRODEMA**  
www.parklexprodema.com

PRODUCT	NATURHARDPANEL	SYSTEM	INTERIOR HANGING HOOK SYSTEM FOR WALLS AND CEILINGS	DRAWN BY	Joseba Salbide	DATE	04/2024
PLAN#	NH1-05-G.P.	TITLE	GENERAL PERSPECTIVE	APPROVED BY	Maialen Irastorza	PAGE	1 / 20

There are two options for locating the hooks depending if the panels will be installed on ceilings or walls.

### On ceilings

Parklex Prodema recommends to fasten the hooks at the back subframe when panels are to be installed on ceilings so it prevents pieces from falling down. This can only be achieved by placing the hooks at the edge of the panel, as shown on the image below.

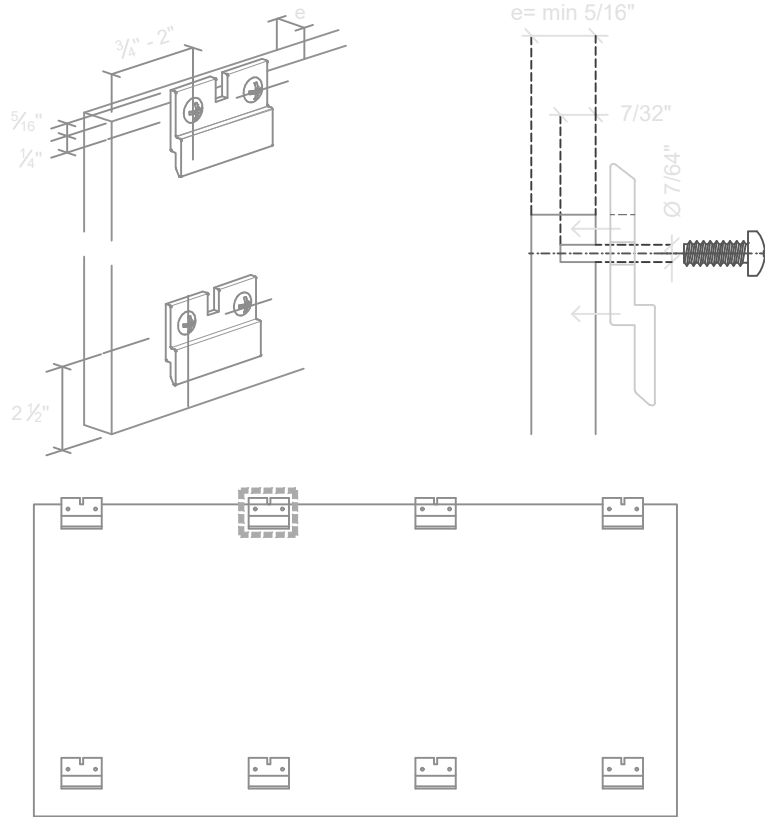

At least one fixed point per panel

### On walls

On walls the hooks can be placed either at the edge or on the inner part of the panel, as shown on the image below.

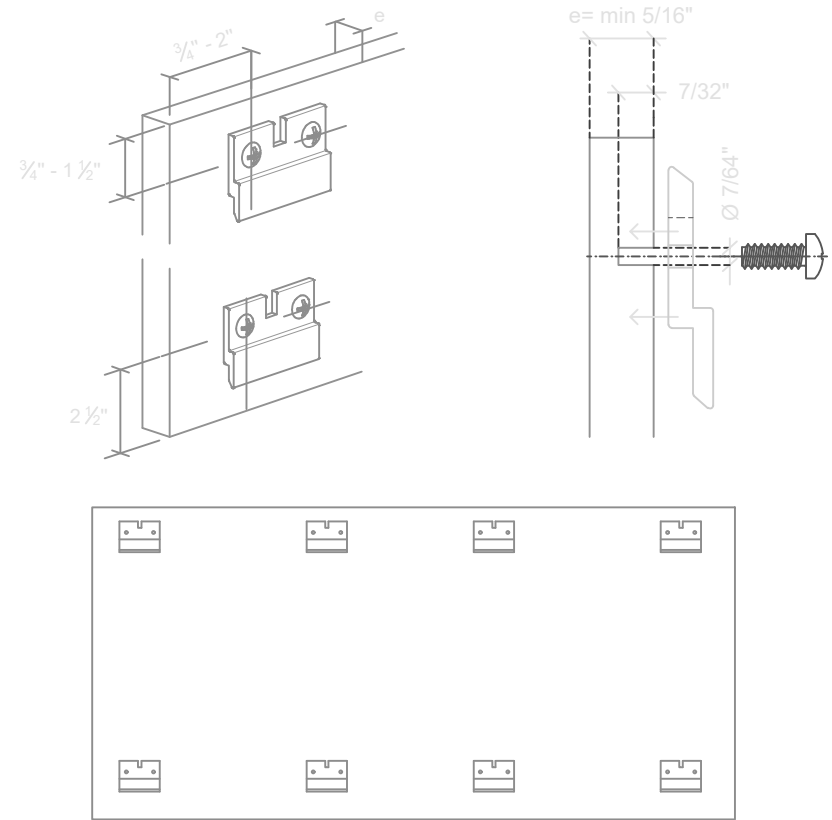

Measurements in inches are approximated. Real measurements in mm.

FIXING DETAIL

MEASURES: INCH & MM

**PARKLEX PRODEMA**  
www.parklexprodema.com

PRODUCT	NATURHARDPANEL
PLAN#	NH1-05-H.L.

SYSTEM	INTERIOR HANGING HOOK SYSTEM FOR WALLS AND CEILINGS
TITLE	HOOK LOCATION

DRAWN BY	Joseba Salbide
APPROVED BY	Maialen Irastorza

DATE	04/2024
PAGE	2 / 20

STEP 1

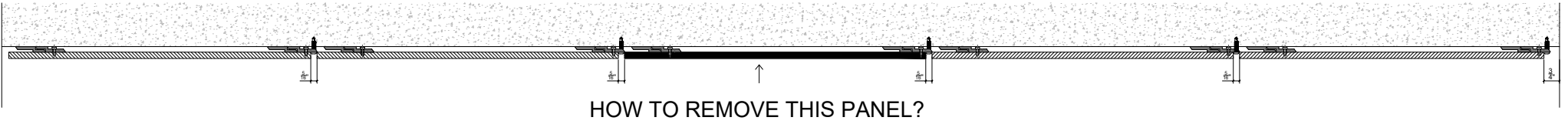

STEP 2

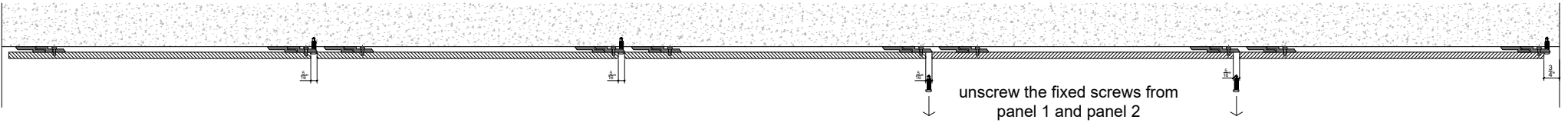

STEP 3

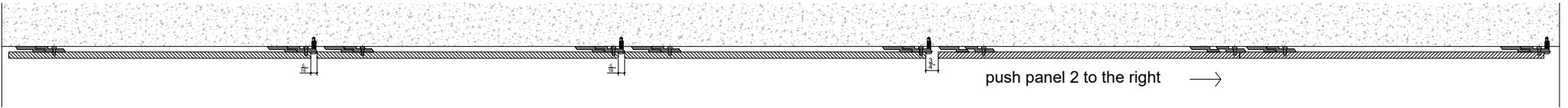

STEP 4

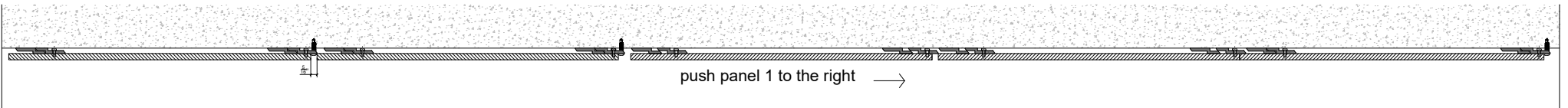

STEP 5

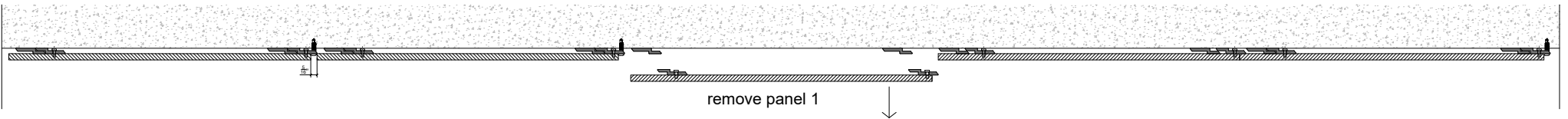

<b>PARKLEX PRODEMA</b> www.parklexprodema.com	PRODUCT NATURHARDPANEL	SYSTEM INTERIOR HANGING HOOK SYSTEM FOR WALLS AND CEILINGS	DRAWN BY Joseba Salbide	DATE 04/2024
	PLAN# NH1-05-G.S.	TITLE PANEL REMOVAL	APPROVED BY Maialen Irastorza	PAGE 3 / 20

1	NATURHARDPANEL
2	Screws
2.1	Panel screw - on the rear of the panel
2.2	Clip fixing screw*
2.3	Wall fixing screw - by others
3	Profiles
3.1	Interior hanging rail
4	Interior hanging hook for walls and ceilings
6	Dropped ceiling subframe - by others

A	Panel thickness 5/16" (8mm)
B	Expansion joint 1/4" (6mm)
C	Chamber depth min. 9/32" (7mm)
D	Top expansion joint 3/4" (20mm)
E	Clip fixing screw joint (when needed) 5/16" (8mm)

\* PARKLEXPRODEMA offers fixing screw for metal and wood substrates

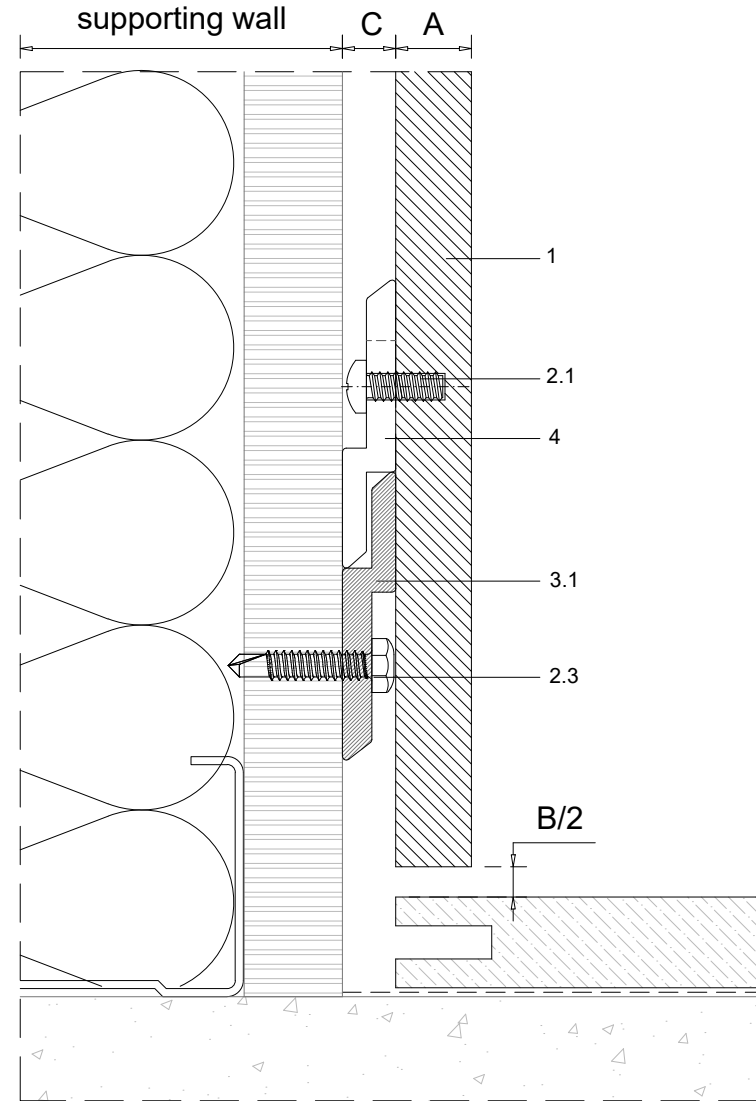
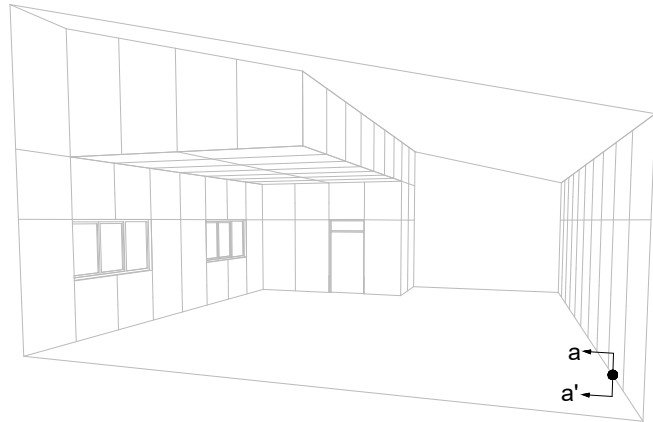

Scale 1:1

Measures: inch

Measurements in inches are approximate. Real measurements in mm.

PARKLEX PRODEMA recommends to paint the subframe behind the panels in black when the subframe is visible through the joint.

**PARKLEX PRODEMA**  
www.parklexprodema.com

PRODUCT	NATURHARDPANEL	SYSTEM	INTERIOR HANGING HOOK SYSTEM FOR WALLS AND CEILINGS	DRAWN BY	Joseba Salbide	DATE	04/2024
PLAN#	NH1-05-A	TITLE	DETAIL A-A' // WALL BASE	APPROVED BY	Maialen Irastorza	PAGE	4 / 20

1	NATURHARDPANEL
2	Screws
2.1	Panel screw - on the rear of the panel
2.2	Clip fixing screw*
2.3	Wall fixing screw - by others
3	Profiles
3.1	Interior hanging rail
4	Interior hanging hook for walls and ceilings
6	Dropped ceiling subframe - by others

A	Panel thickness 5/16" (8mm)
B	Expansion joint 1/4" (6mm)
C	Chamber depth min. 9/32" (7mm)
D	Top expansion joint 3/4" (20mm)
E	Clip fixing screw joint (when needed) 5/16" (8mm)

\* PARKLEXPRODEMA offers fixing screw for metal and wood substrates

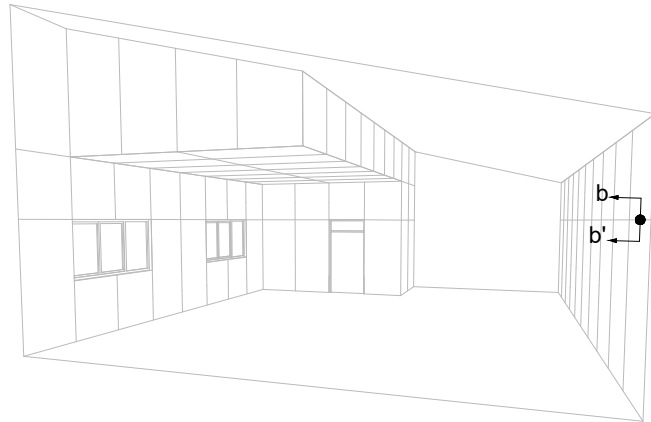

Measurements in inches are approximate. Real measurements in mm.

PARKLEX PRODEMA recommends to paint the subframe behind the panels in black when the subframe is visible through the joint.

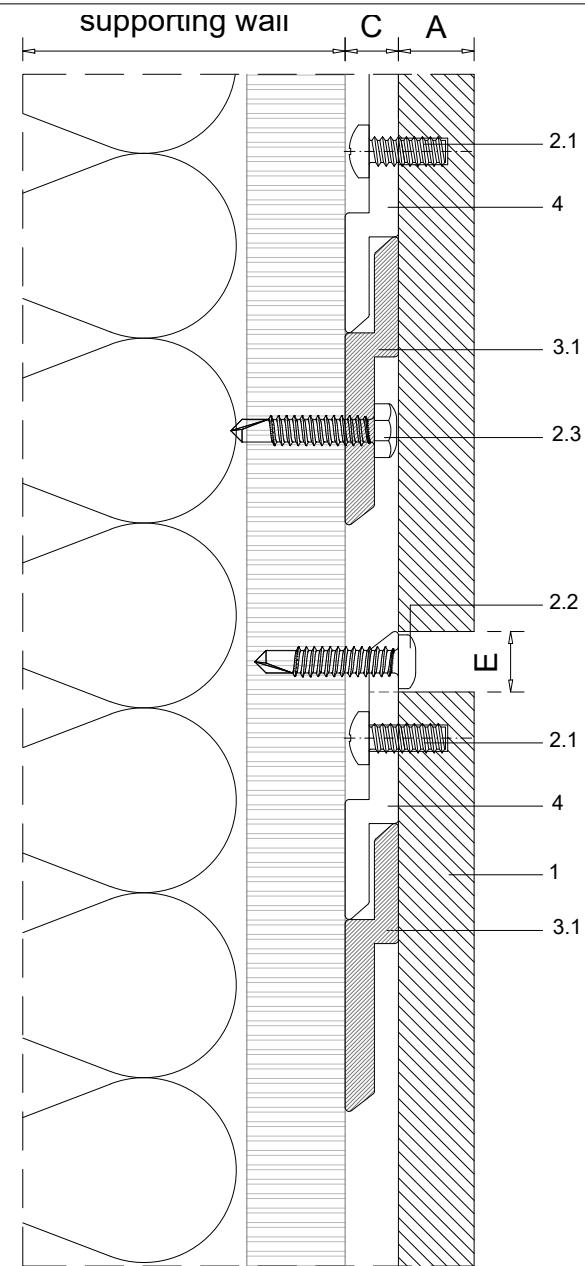

Scale 1:1

Measures: inch

**PARKLEX PRODEMA**  
www.parklexprodema.com

PRODUCT	NATURHARDPANEL	SYSTEM	INTERIOR HANGING HOOK SYSTEM FOR WALLS AND CEILINGS	DRAWN BY	Joseba Salbide	DATE	04/2024
PLAN#	NH1-05-B	TITLE	DETAIL B-B' // HORIZONTAL JOINT	APPROVED BY	Maialen Irastorza	PAGE	5 / 20

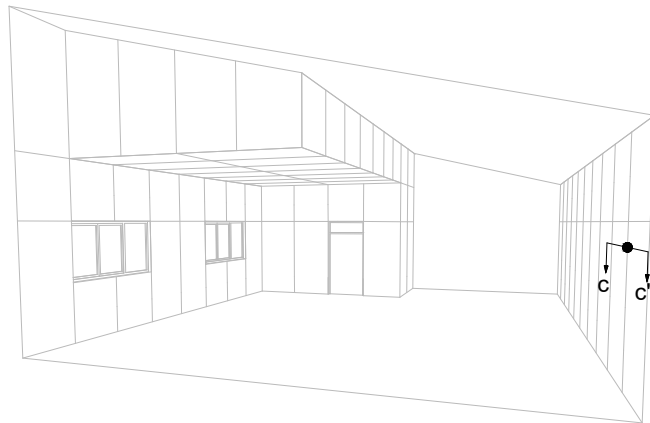
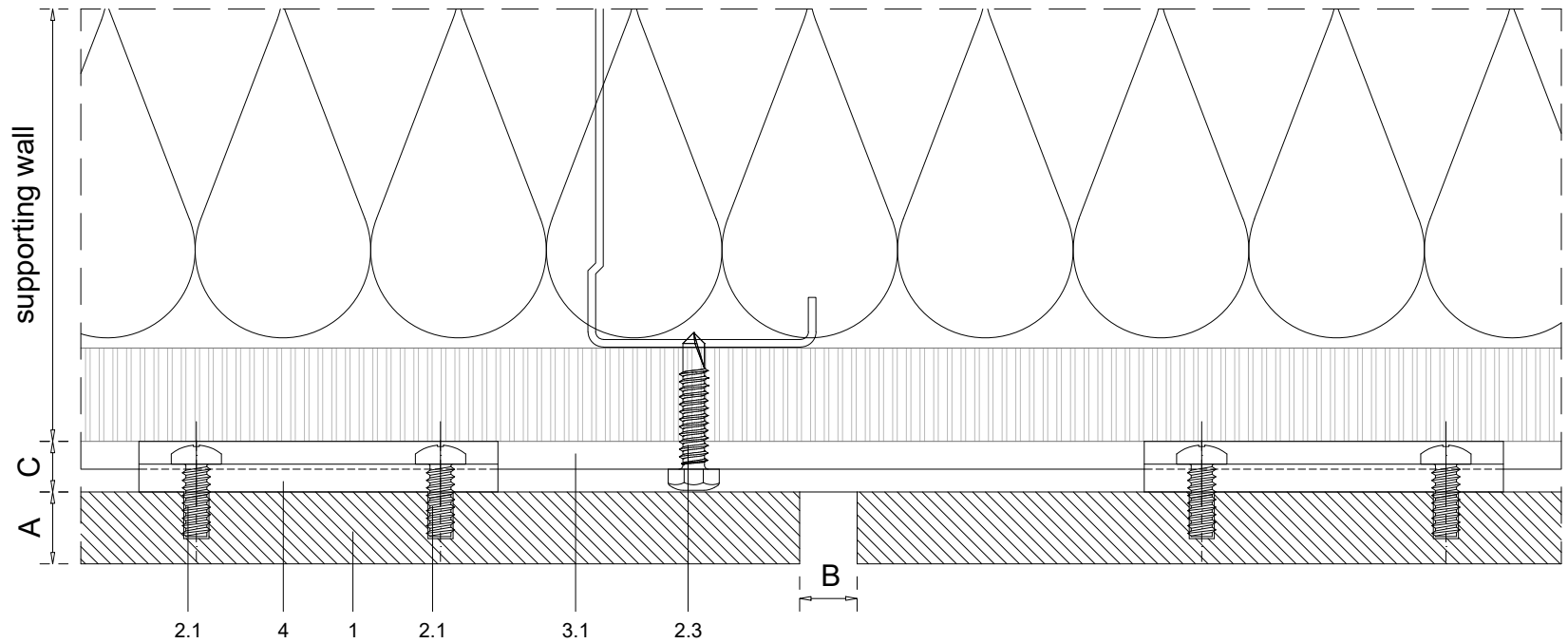

1	NATURHARDPANEL
2	Screws
2.1	Panel screw - on the rear of the panel
2.2	Clip fixing screw*
2.3	Wall fixing screw - by others
3	Profiles
3.1	Interior hanging rail
4	Interior hanging hook for walls and ceilings
6	Dropped ceiling subframe - by others

A	Panel thickness 5/16" (8mm)
B	Expansion joint 1/4" (6mm)
C	Chamber depth min. 9/32" (7mm)
D	Top expansion joint 3/4" (20mm)
E	Clip fixing screw joint (when needed) 5/16" (8mm)

\* PARKLEXPRODEMA offers fixing screw for metal and wood substrates

Measurements in inches are approximate. Real measurements in mm.

PARKLEX PRODEMA recommends to paint the subframe behind the panels in black when the subframe is visible through the joint.

Scale 1:1

Measures: inch

 www.parklexprodema.com	PRODUCT	SYSTEM	DRAWN BY	DATE
	NATURHARDPANEL	INTERIOR HANGING HOOK SYSTEM FOR WALLS AND CEILINGS	Joseba Salbide	04/2024
	PLAN#	TITLE	APPROVED BY	PAGE
	NH1-05-C	DETAIL C-C' // VERTICAL JOINT	Maialen Irastorza	6 / 20

1	NATURHARDPANEL
2	Screws
2.1	Panel screw - on the rear of the panel
2.2	Clip fixing screw*
2.3	Wall fixing screw - by others
3	Profiles
3.1	Interior hanging rail
4	Interior hanging hook for walls and ceilings
6	Dropped ceiling subframe - by others

A	Panel thickness 5/16" (8mm)
B	Expansion joint 1/4" (6mm)
C	Chamber depth min. 9/32" (7mm)
D	Top expansion joint 3/4" (20mm)
E	Clip fixing screw joint (when needed) 5/16" (8mm)

\* PARKLEXPRODEMA offers fixing screw for metal and wood substrates

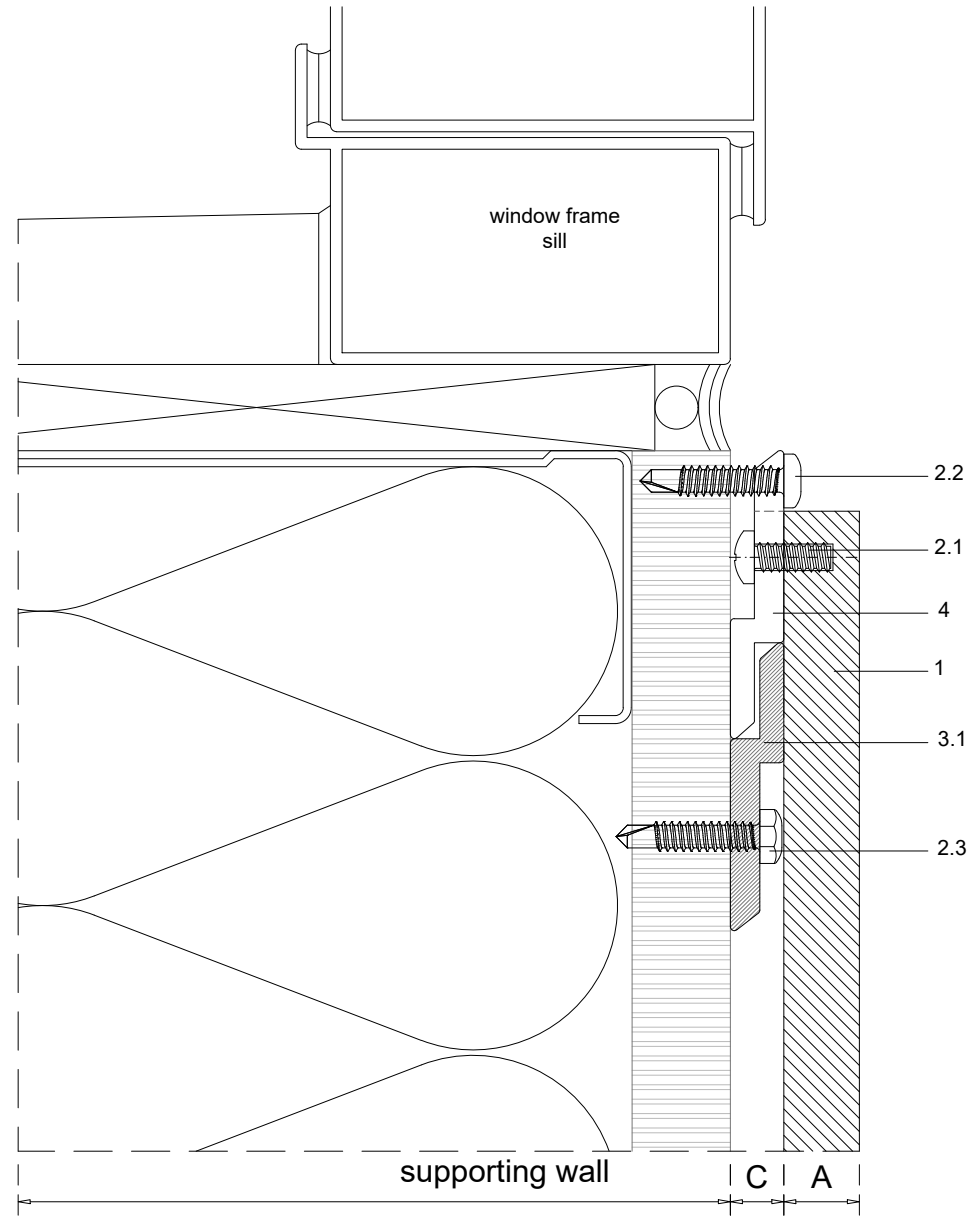
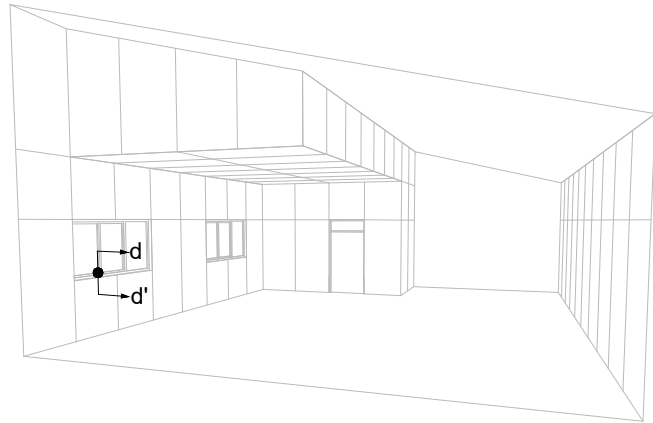

Measurements in inches are approximate. Real measurements in mm.

PARKLEX PRODEMA recommends to paint the subframe behind the panels in black when the subframe is visible through the joint.

Scale 1:1

Measures: inch

**PARKLEX PRODEMA**  
www.parklexprodema.com

PRODUCT	NATURHARDPANEL	SYSTEM	INTERIOR HANGING HOOK SYSTEM FOR WALLS AND CEILINGS	DRAWN BY	Joseba Salbide	DATE	04/2024
PLAN#	NH1-05-D	TITLE	DETAIL D-D' // WINDOW SILL	APPROVED BY	Maialen Irastorza	PAGE	7 / 20

1	NATURHARDPANEL
2	Screws
2.1	Panel screw - on the rear of the panel
2.2	Clip fixing screw*
2.3	Wall fixing screw - by others
3	Profiles
3.1	Interior hanging rail
4	Interior hanging hook for walls and ceilings
6	Dropped ceiling subframe - by others

A	Panel thickness 5/16" (8mm)
B	Expansion joint 1/4" (6mm)
C	Chamber depth min. 9/32" (7mm)
D	Top expansion joint 3/4" (20mm)
E	Clip fixing screw joint (when needed) 5/16" (8mm)

\* PARKLEXPRODEMA offers fixing screw for metal and wood substrates

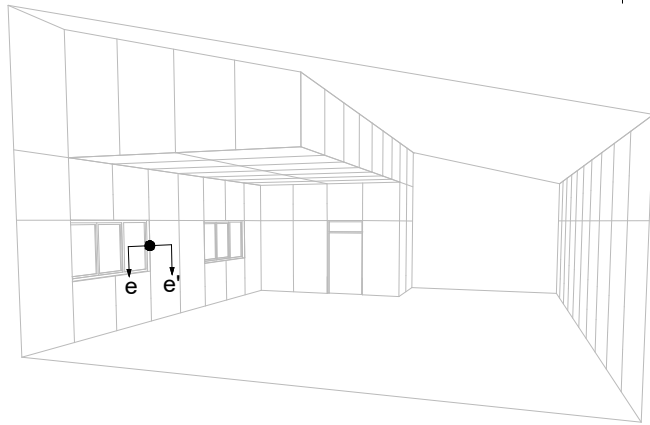
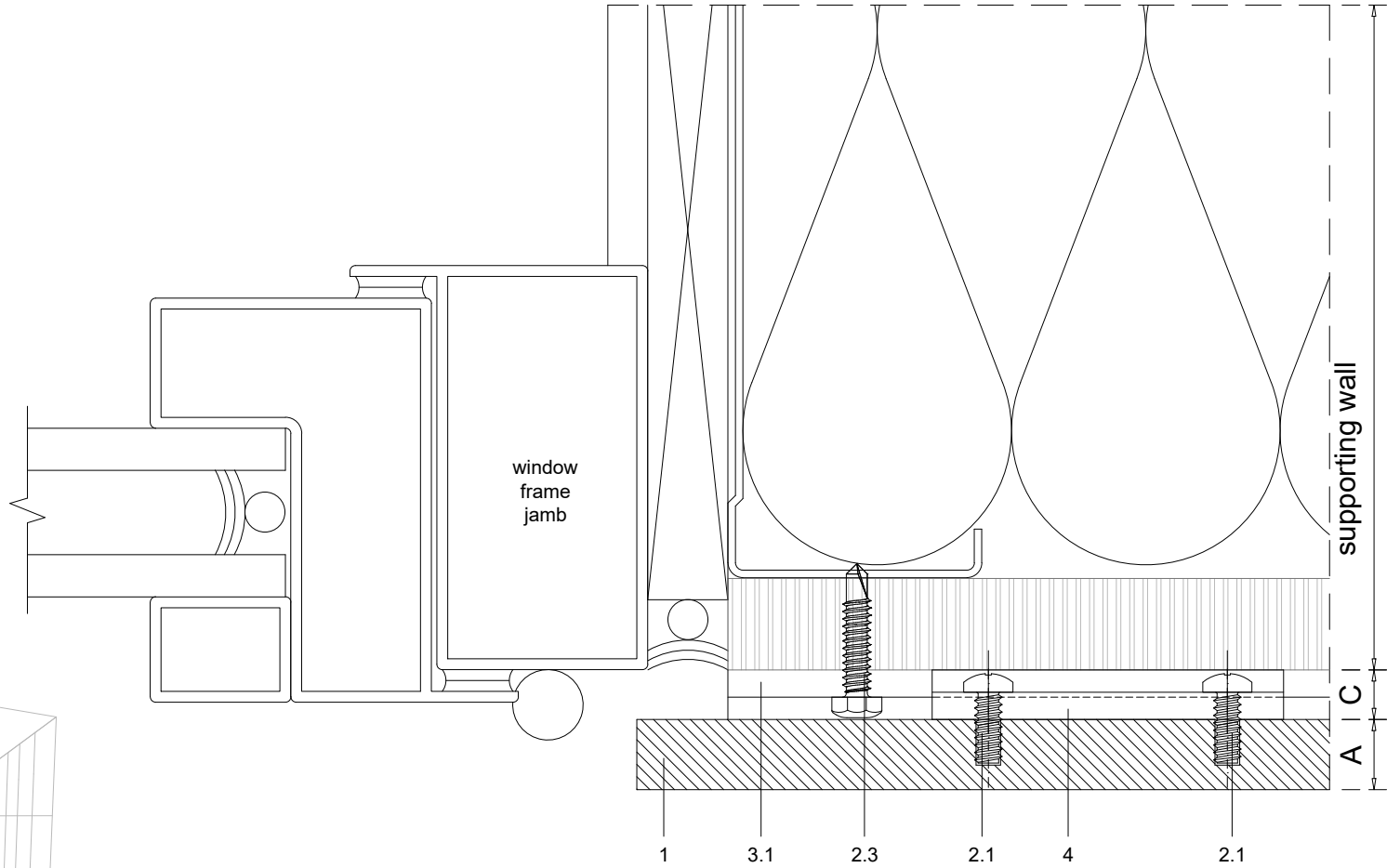

Measurements in inches are approximate. Real measurements in mm.

PARKLEX PRODEMA recommends to paint the subframe behind the panels in black when the subframe is visible through the joint.

Scale 1:1

Measures: inch

 <a href="http://www.parklexprodema.com">www.parklexprodema.com</a>	PRODUCT	SYSTEM	DRAWN BY	DATE
	NATURHARDPANEL	INTERIOR HANGING HOOK SYSTEM FOR WALLS AND CEILINGS	Joseba Salbide	04/2024
	PLAN#	TITLE	APPROVED BY	PAGE
	NH1-05-E	DETAIL E-E' // WINDOW JAMB	Maialen Irastorza	8 / 20

1	NATURHARDPANEL
2	Screws
2.1	Panel screw - on the rear of the panel
2.2	Clip fixing screw*
2.3	Wall fixing screw - by others
3	Profiles
3.1	Interior hanging rail
4	Interior hanging hook for walls and ceilings
6	Dropped ceiling subframe - by others

A	Panel thickness 5/16" (8mm)
B	Expansion joint 1/4" (6mm)
C	Chamber depth min. 9/32" (7mm)
D	Top expansion joint 3/4" (20mm)
E	Clip fixing screw joint (when needed) 5/16" (8mm)

\* PARKLEXPRODEMA offers fixing screw for metal and wood substrates

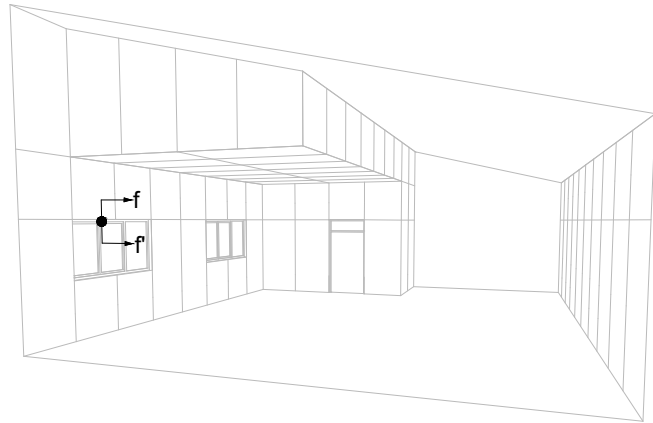

Measurements in inches are approximate. Real measurements in mm.  
 PARKLEX PRODEMA recommends to paint the subframe behind the panels in black when the subframe is visible through the joint.

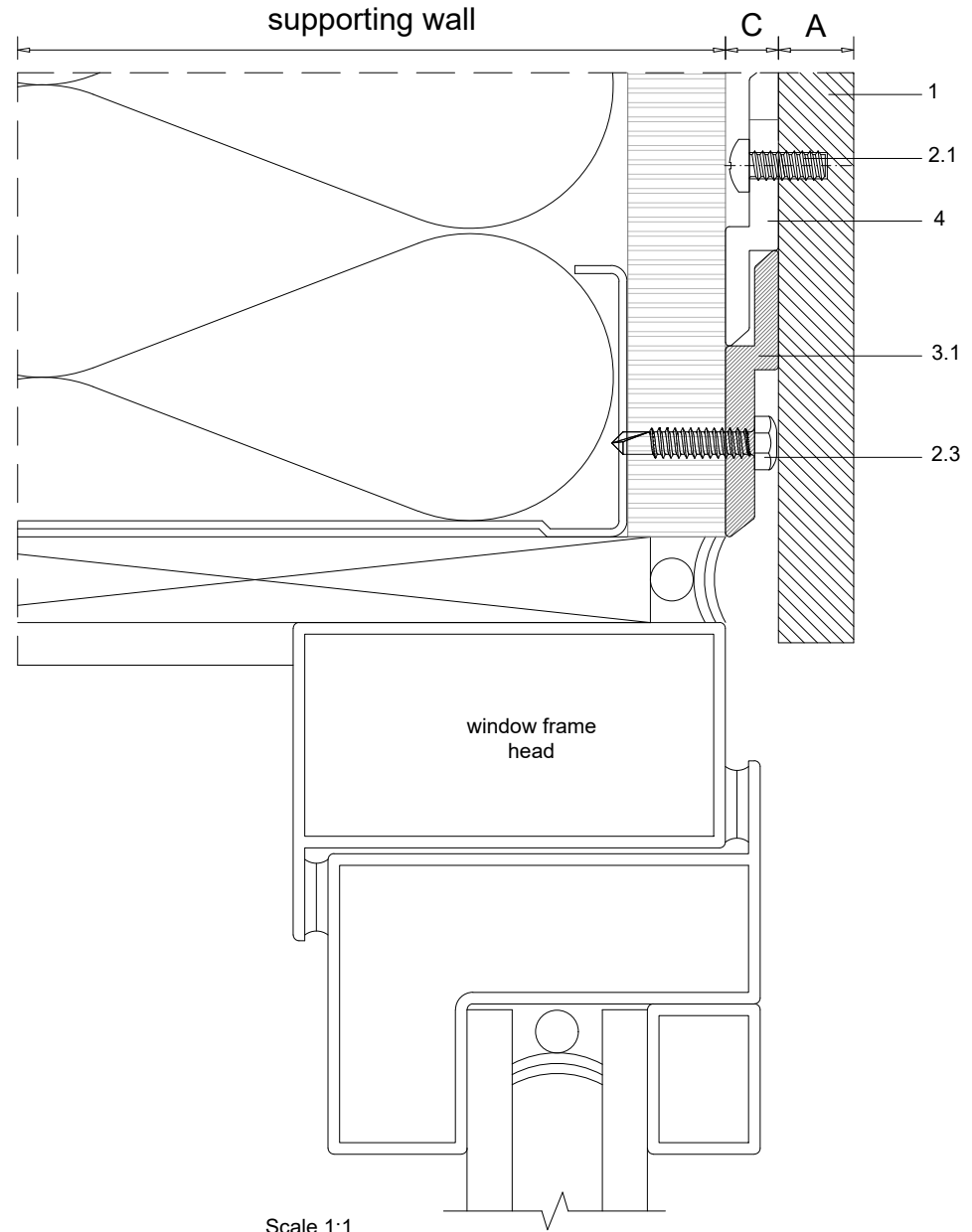

**PARKLEX PRODEMA**  
 www.parklexprodema.com

PRODUCT	NATURHARDPANEL	SYSTEM	INTERIOR HANGING HOOK SYSTEM FOR WALLS AND CEILINGS	DRAWN BY	Joseba Salbide	DATE	04/2024
PLAN#	NH1-05-F	TITLE	DETAIL F-F' // WINDOW HEAD	APPROVED BY	Maialen Irastorza	PAGE	9 / 20

1	NATURHARDPANEL
2	Screws
2.1	Panel screw - on the rear of the panel
2.2	Clip fixing screw*
2.3	Wall fixing screw - by others
3	Profiles
3.1	Interior hanging rail
4	Interior hanging hook for walls and ceilings
6	Dropped ceiling subframe - by others

A	Panel thickness 5/16" (8mm)
B	Expansion joint 1/4" (6mm)
C	Chamber depth min. 9/32" (7mm)
D	Top expansion joint 3/4" (20mm)
E	Clip fixing screw joint (when needed) 5/16" (8mm)

\* PARKLEXPRODEMA offers fixing screw for metal and wood substrates

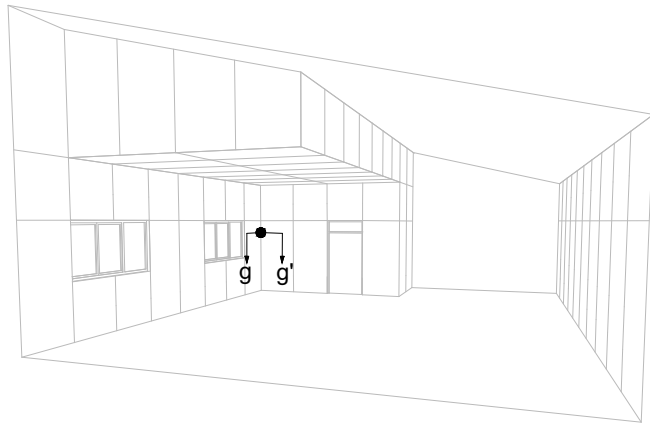

Measurements in inches are approximate. Real measurements in mm.  
 PARKLEX PRODEMA recommends to paint the subframe behind the panels in black when the subframe is visible through the joint.

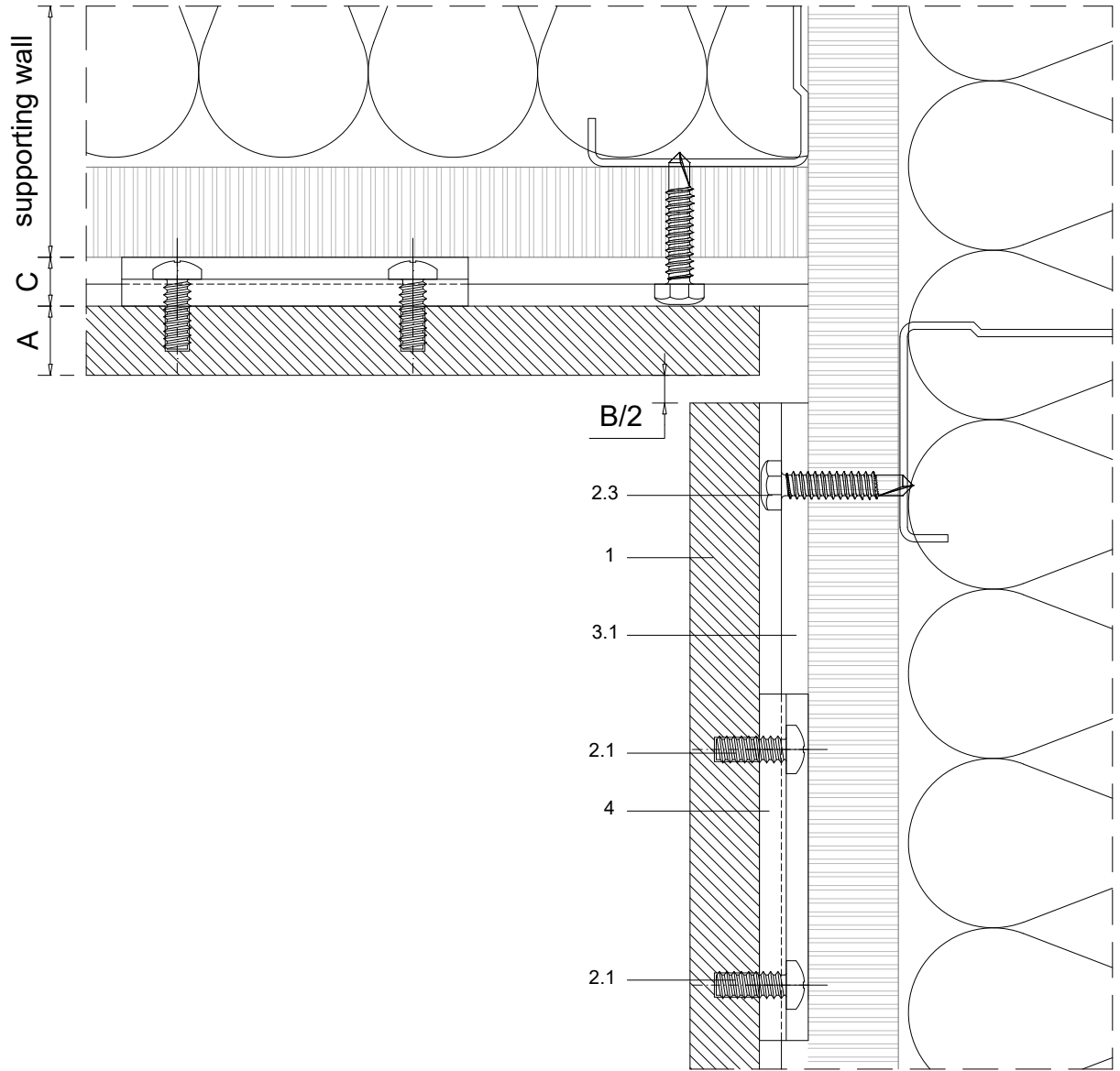

Scale 1:1

Measures: inch

 www.parklexprodema.com	PRODUCT	SYSTEM	DRAWN BY	DATE
	NATURHARDPANEL	INTERIOR HANGING HOOK SYSTEM FOR WALLS AND CEILINGS	Joseba Salbide	04/2024
	PLAN#	TITLE	APPROVED BY	PAGE
	NH1-05-G	DETAIL G-G' // INSIDE CORNER	Maialen Irastorza	10 / 20

1	NATURHARDPANEL
2	Screws
2.1	Panel screw - on the rear of the panel
2.2	Clip fixing screw*
2.3	Wall fixing screw - by others
3	Profiles
3.1	Interior hanging rail
4	Interior hanging hook for walls and ceilings
6	Dropped ceiling subframe - by others

A	Panel thickness 5/16" (8mm)
B	Expansion joint 1/4" (6mm)
C	Chamber depth min. 9/32" (7mm)
D	Top expansion joint 3/4" (20mm)
E	Clip fixing screw joint (when needed) 5/16" (8mm)

\* PARKLEXPRODEMA offers fixing screw for metal and wood substrates

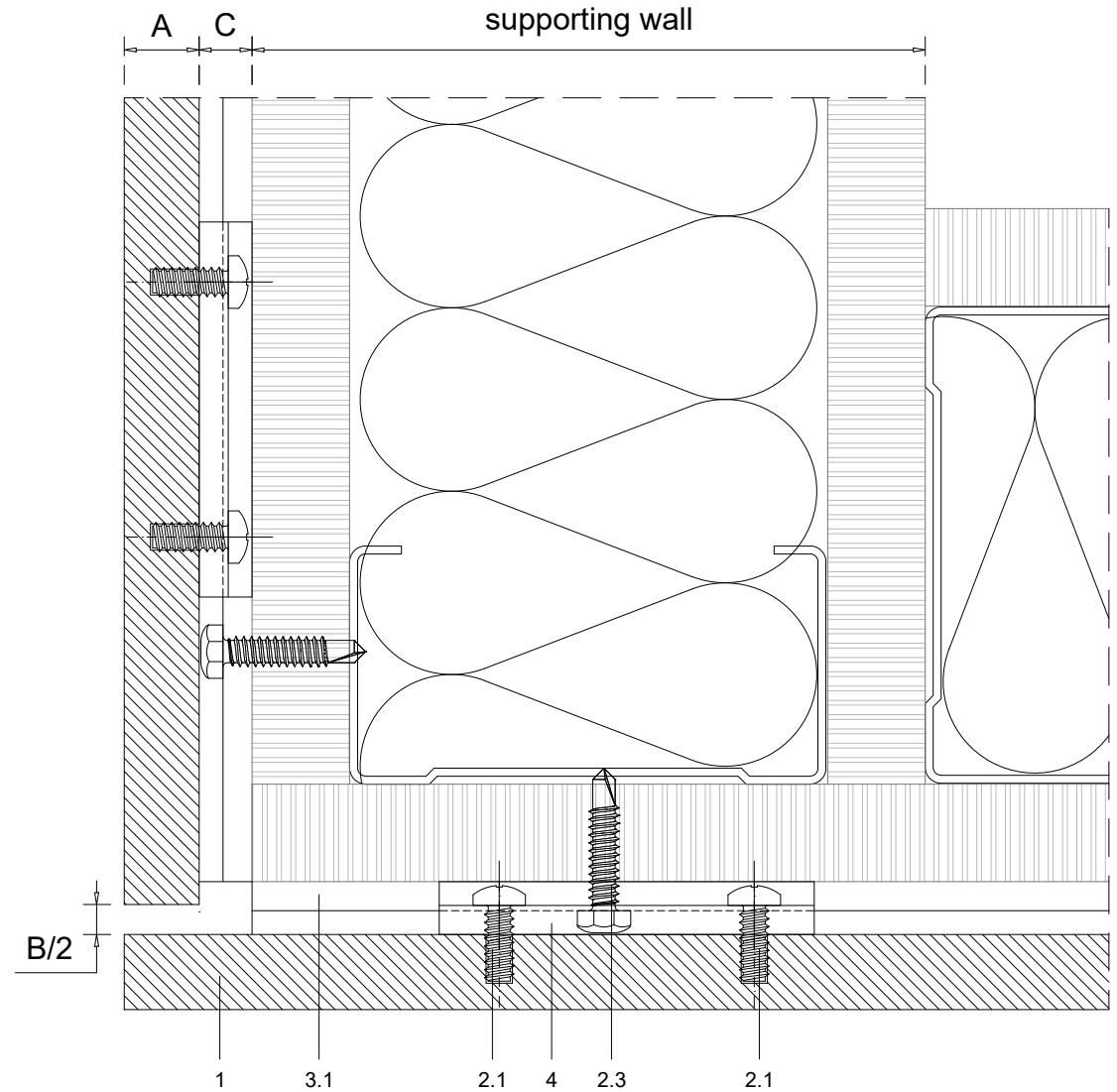
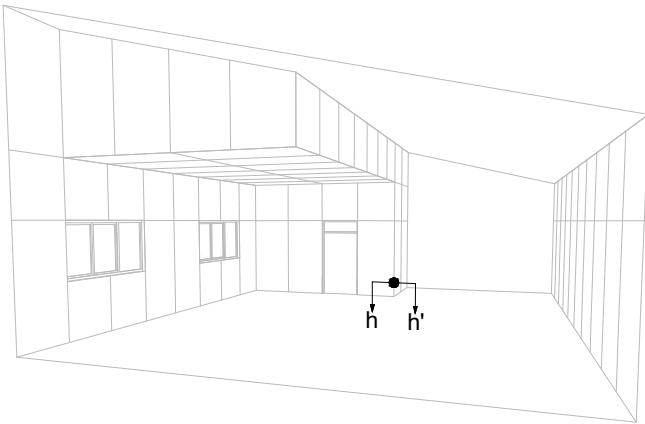

Measurements in inches are approximate. Real measurements in mm.

PARKLEX PRODEMA recommends to paint the subframe behind the panels in black when the subframe is visible through the joint.

Scale 1:1

Measures: inch

**PARKLEX PRODEMA**  
www.parklexprodema.com

PRODUCT	NATURHARDPANEL	SYSTEM	INTERIOR HANGING HOOK SYSTEM FOR WALLS AND CEILINGS	DRAWN BY	Joseba Salbide	DATE	04/2024
PLAN#	NH1-05-H1	TITLE	DETAIL H-H' // OUTSIDE CORNER	APPROVED BY	Maialen Irastorza	PAGE	11 / 20

1	NATURHARDPANEL
2	Screws
2.1	Panel screw - on the rear of the panel
2.2	Clip fixing screw*
2.3	Wall fixing screw - by others
3	Profiles
3.1	Interior hanging rail
4	Interior hanging hook for walls and ceilings
5	Corner trim - black lackered
6	Dropped ceiling subframe - by others

A	Panel thickness 5/16" (8mm)
B	Expansion joint 1/4" (6mm)
C	Chamber depth min. 9/32" (7mm)
D	Top expansion joint 3/4" (20mm)
E	Clip fixing screw joint (when needed) 5/16" (8mm)

\* PARKLEXPRODEMA offers fixing screw for metal and wood substrates

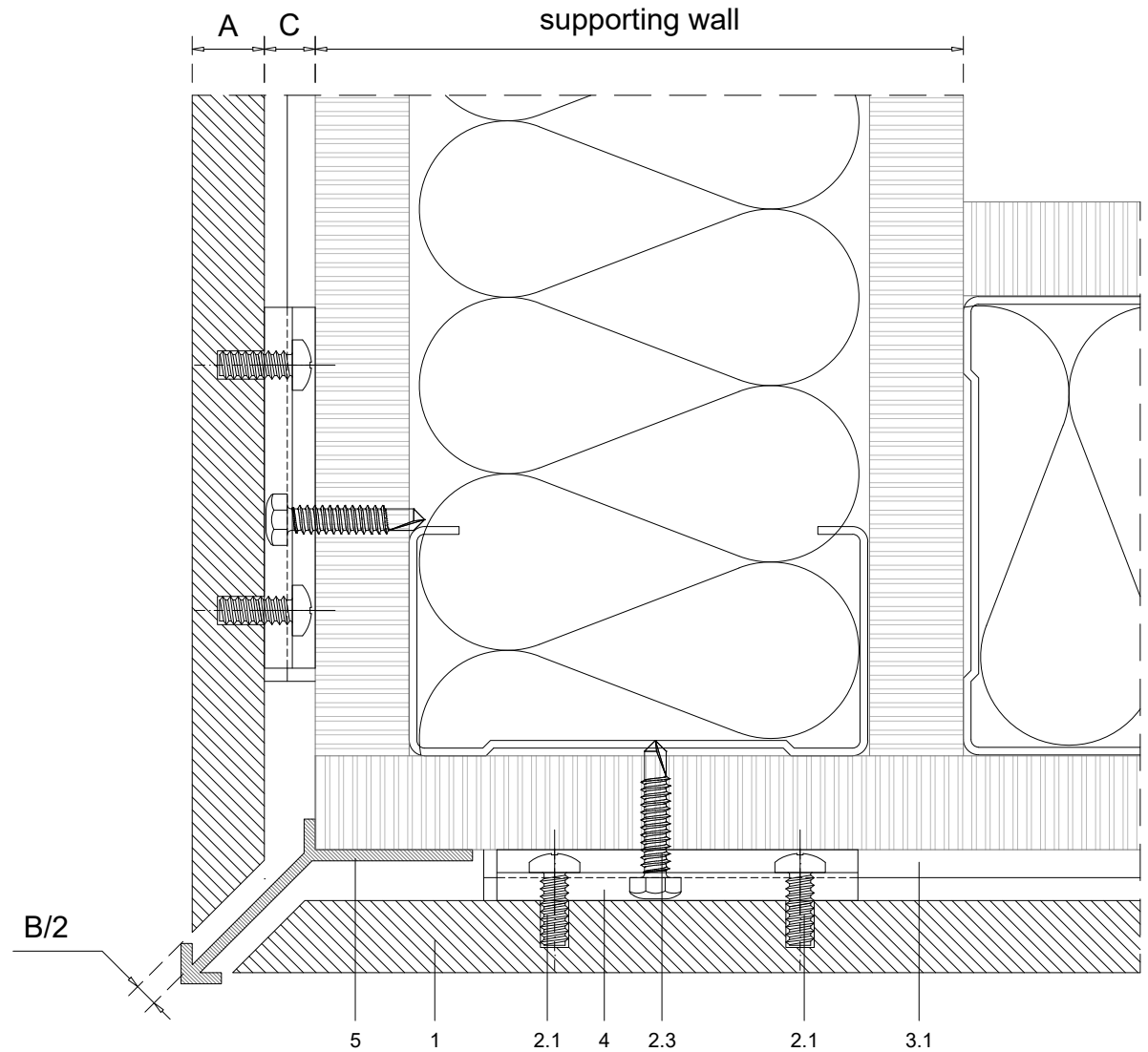
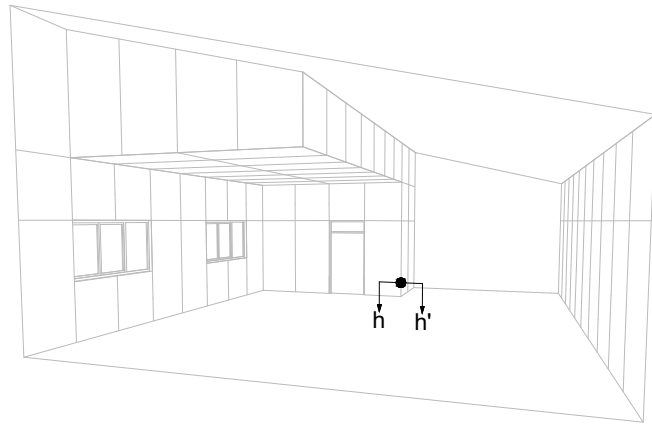

Measurements in inches are approximate. Real measurements in mm.

PARKLEX PRODEMA recommends to paint the subframe behind the panels in black when the subframe is visible through the joint.

Scale 1:1

Measures: inch

 www.parklexprodema.com	PRODUCT	SYSTEM	DRAWN BY	DATE
	NATURHARDPANEL	INTERIOR HANGING HOOK SYSTEM FOR WALLS AND CEILINGS	Joseba Salbide	04/2024
	PLAN#	TITLE	APPROVED BY	PAGE
	NH1-05-H2	DETAIL H-H' // OUTSIDE CORNER	Maialen Irastorza	12 / 20

1	NATURHARDPANEL
2	Screws
2.1	Panel screw - on the rear of the panel
2.2	Clip fixing screw*
2.3	Wall fixing screw - by others
3	Profiles
3.1	Interior hanging rail
4	Interior hanging hook for walls and ceilings
5	L30X15mm trim - black lackered
6	Dropped ceiling subframe - by others

A	Panel thickness 5/16" (8mm)
B	Expansion joint 1/4" (6mm)
C	Chamber depth min. 9/32" (7mm)
D	Top expansion joint 3/4" (20mm)
E	Clip fixing screw joint (when needed) 5/16" (8mm)

\* PARKLEXPRODEMA offers fixing screw for metal and wood substrates

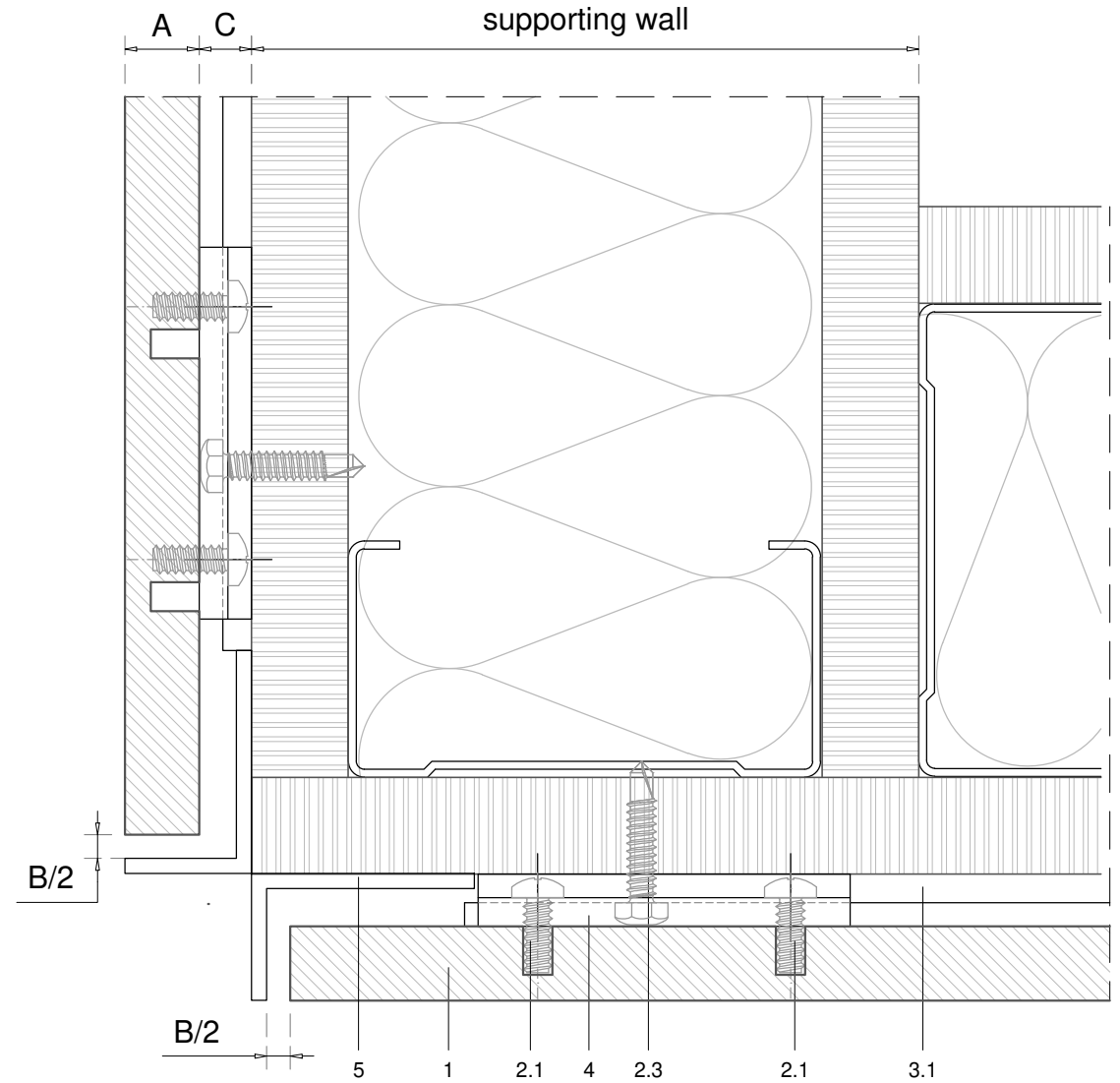
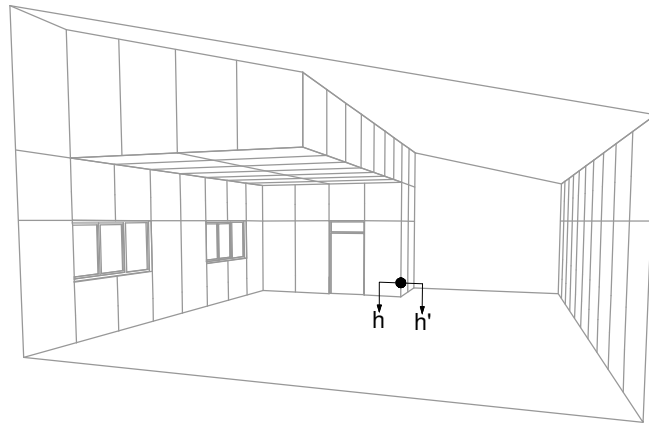

Measurements in inches are approximate. Real measurements in mm.  
 PARKLEX PRODEMA recommends to paint the subframe behind the panels in black when the subframe is visible through the joint.

Scale 1:1

Measures: inch

 www.parklexprodema.com	PRODUCT	SYSTEM	DRAWN BY	DATE
	NATURHARDPANEL	INTERIOR HANGING HOOK SYSTEM FOR WALLS AND CEILINGS	Joseba Salbide	04/2024
	PLAN#	TITLE	APPROVED BY	PAGE
	NH1-05-H3	DETAIL H-H' // OUTSIDE CORNER	Maialen Irastorza	13 / 20

1	NATURHARDPANEL
2	Screws
2.1	Panel screw - on the rear of the panel
2.2	Clip fixing screw*
2.3	Wall fixing screw - by others
3	Profiles
3.1	Interior hanging rail
4	Interior hanging hook for walls and ceilings
6	Dropped ceiling subframe - by others

A	Panel thickness 5/16" (8mm)
B	Expansion joint 1/4" (6mm)
C	Chamber depth min. 9/32" (7mm)
D	Top expansion joint 3/4" (20mm)
E	Clip fixing screw joint (when needed) 5/16" (8mm)

\* PARKLEXPRODEMA offers fixing screw for metal and wood substrates

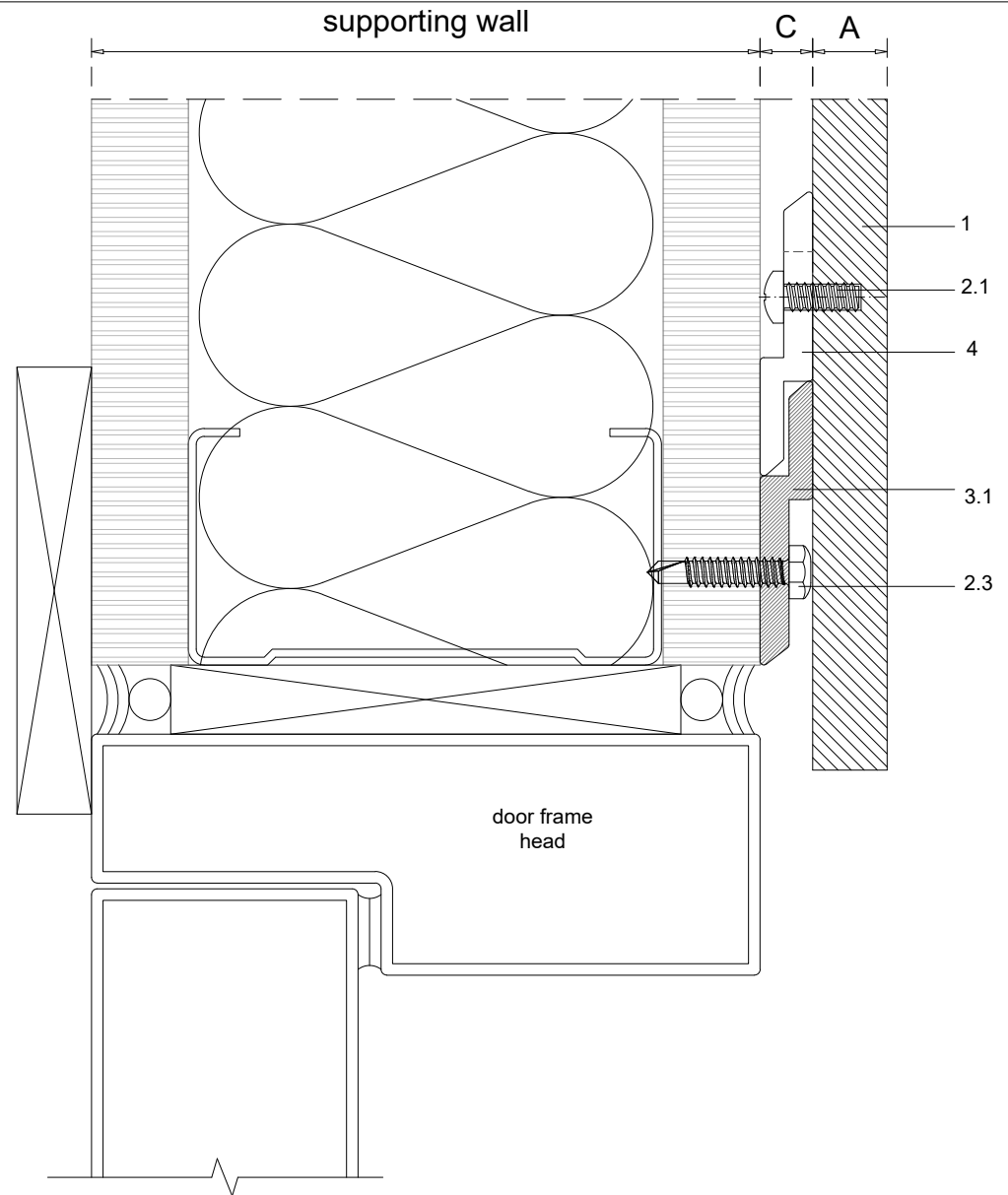
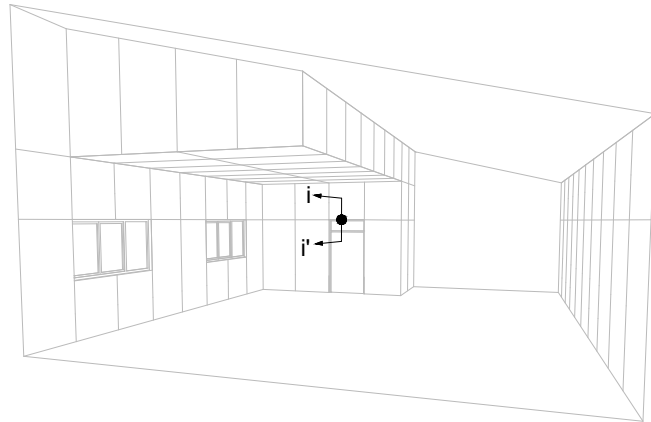

Scale 1:1

Measures: inch

Measurements in inches are approximate. Real measurements in mm.

PARKLEX PRODEMA recommends to paint the subframe behind the panels in black when the subframe is visible through the joint.

**PARKLEX PRODEMA**  
www.parklexprodema.com

PRODUCT	NATURHARDPANEL	SYSTEM	INTERIOR HANGING HOOK SYSTEM FOR WALLS AND CEILINGS	DRAWN BY	Joseba Salbide	DATE	04/2024
PLAN#	NH1-05-I	TITLE	DETAIL I-I' // DOOR HEAD	APPROVED BY	Maialen Irastorza	PAGE	14 / 20

1	NATURHARDPANEL
2	Screws
2.1	Panel screw - on the rear of the panel
2.2	Clip fixing screw*
2.3	Wall fixing screw - by others
3	Profiles
3.1	Interior hanging rail
4	Interior hanging hook for walls and ceilings
6	Dropped ceiling subframe - by others

A	Panel thickness 5/16" (8mm)
B	Expansion joint 1/4" (6mm)
C	Chamber depth min. 9/32" (7mm)
D	Top expansion joint 3/4" (20mm)
E	Clip fixing screw joint (when needed) 5/16" (8mm)

\* PARKLEXPRODEMA offers fixing screw for metal and wood substrates

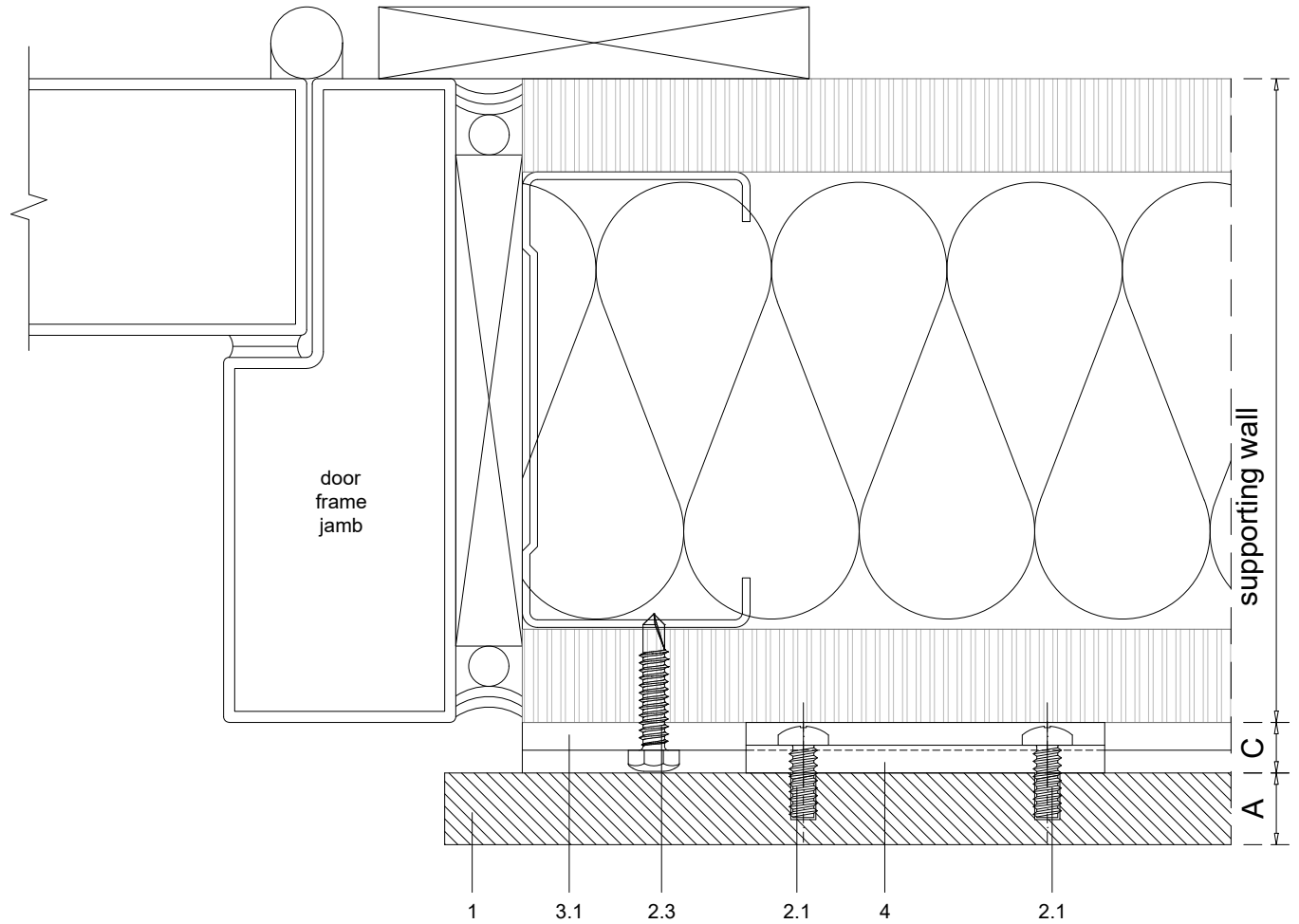
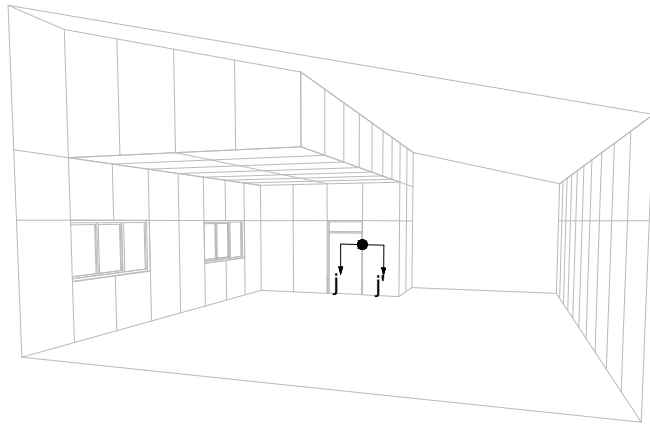

Scale 1:1

Measures: inch

Measurements in inches are approximate. Real measurements in mm.

PARKLEX PRODEMA recommends to paint the subframe behind the panels in black when the subframe is visible through the joint.

<b>PARKLEX PRODEMA</b> www.parklexprodema.com	PRODUCT	SYSTEM	DRAWN BY	DATE
	NATURHARDPANEL	INTERIOR HANGING HOOK SYSTEM FOR WALLS AND CEILINGS	Joseba Salbide	04/2024
	PLAN#	TITLE	APPROVED BY	PAGE
	NH1-05-J	DETAIL J-J' // DOOR JAMB	Maialen Irastorza	15 / 20

1	NATURHARDPANEL
2	Screws
2.1	Panel screw - on the rear of the panel
2.2	Clip fixing screw*
2.3	Wall fixing screw - by others
3	Profiles
3.1	Interior hanging rail
4	Interior hanging hook for walls and ceilings
6	Dropped ceiling subframe - by others

A	Panel thickness 5/16" (8mm)
B	Expansion joint 1/4" (6mm)
C	Chamber depth min. 9/32" (7mm)
D	Top expansion joint 3/4" (20mm)
E	Clip fixing screw joint (when needed) 5/16" (8mm)

\* PARKLEXPRODEMA offers fixing screw for metal and wood substrates

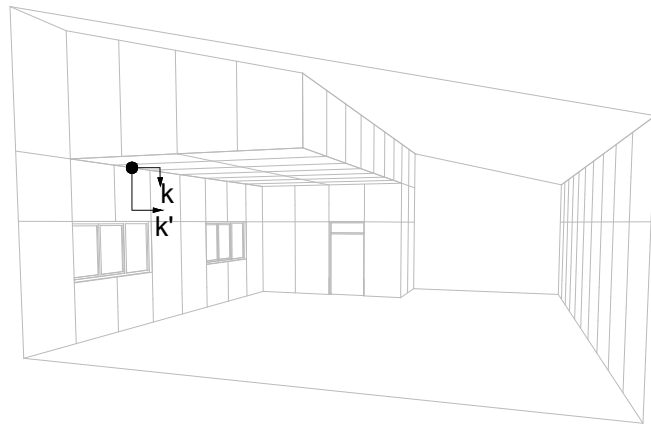

Measurements in inches are approximate. Real measurements in mm.

PARKLEX PRODEMA recommends to paint the subframe behind the panels in black when the subframe is visible through the joint.

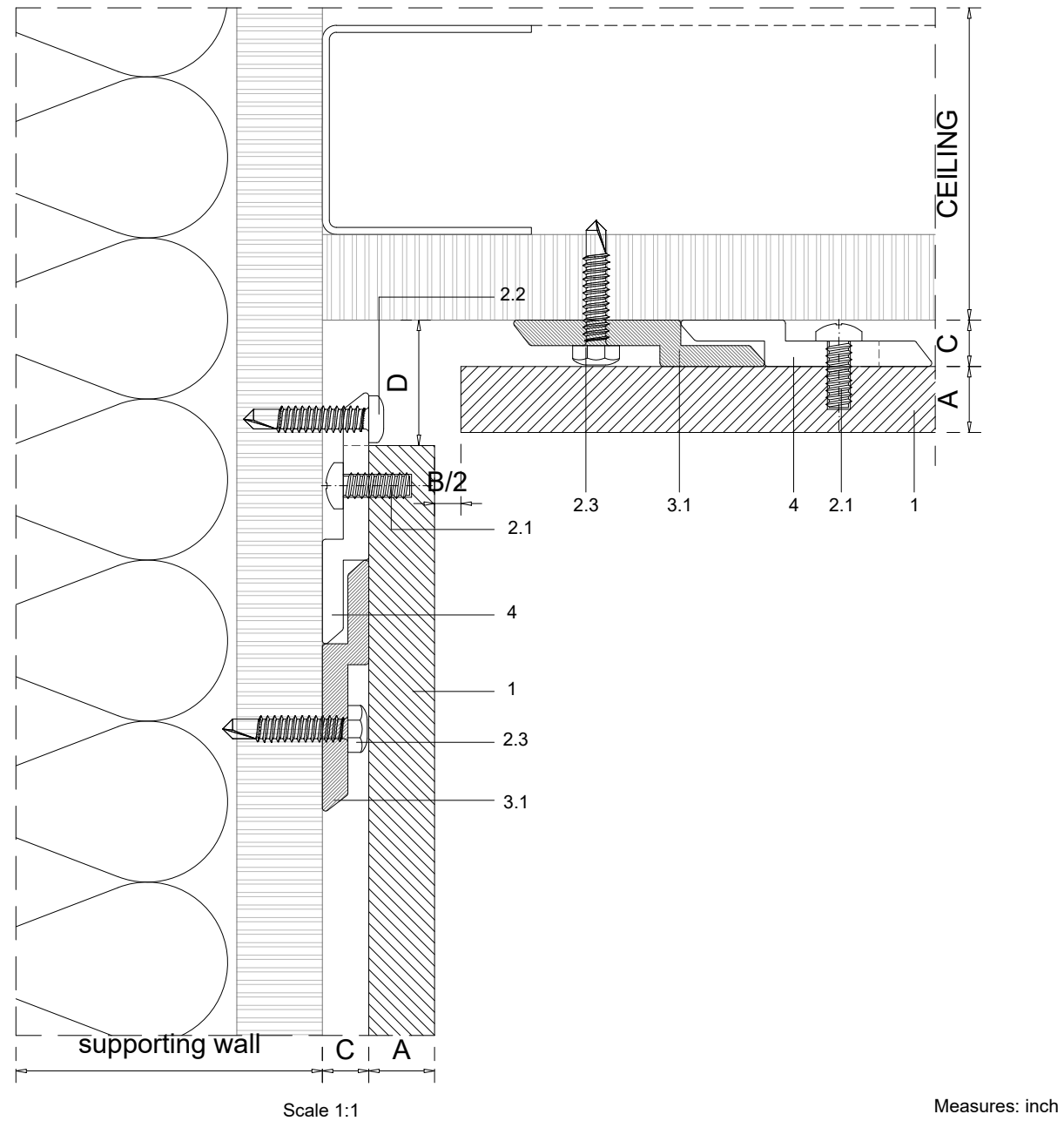

**PARKLEX PRODEMA**  
www.parklexprodema.com

PRODUCT	NATURHARDPANEL	SYSTEM	INTERIOR HANGING HOOK SYSTEM FOR WALLS AND CEILINGS	DRAWN BY	Joseba Salbide	DATE	04/2024
PLAN#	NH1-05-K	TITLE	DETAIL K-K' // WALL/CEILING INTERSECTION	APPROVED BY	Maialen Irastorza	PAGE	16 / 20

1	NATURHARDPANEL
2	Screws
2.1	Panel screw - on the rear of the panel
2.2	Clip fixing screw*
2.3	Wall fixing screw - by others
3	Profiles
3.1	Interior hanging rail
4	Interior hanging hook for walls and ceilings
6	Dropped ceiling subframe - by others

A	Panel thickness 5/16" (8mm)
B	Expansion joint 1/4" (6mm)
C	Chamber depth min. 9/32" (7mm)
D	Top expansion joint 3/4" (20mm)
E	Clip fixing screw joint (when needed) 5/16" (8mm)

\* PARKLEXPRODEMA offers fixing screw for metal and wood substrates

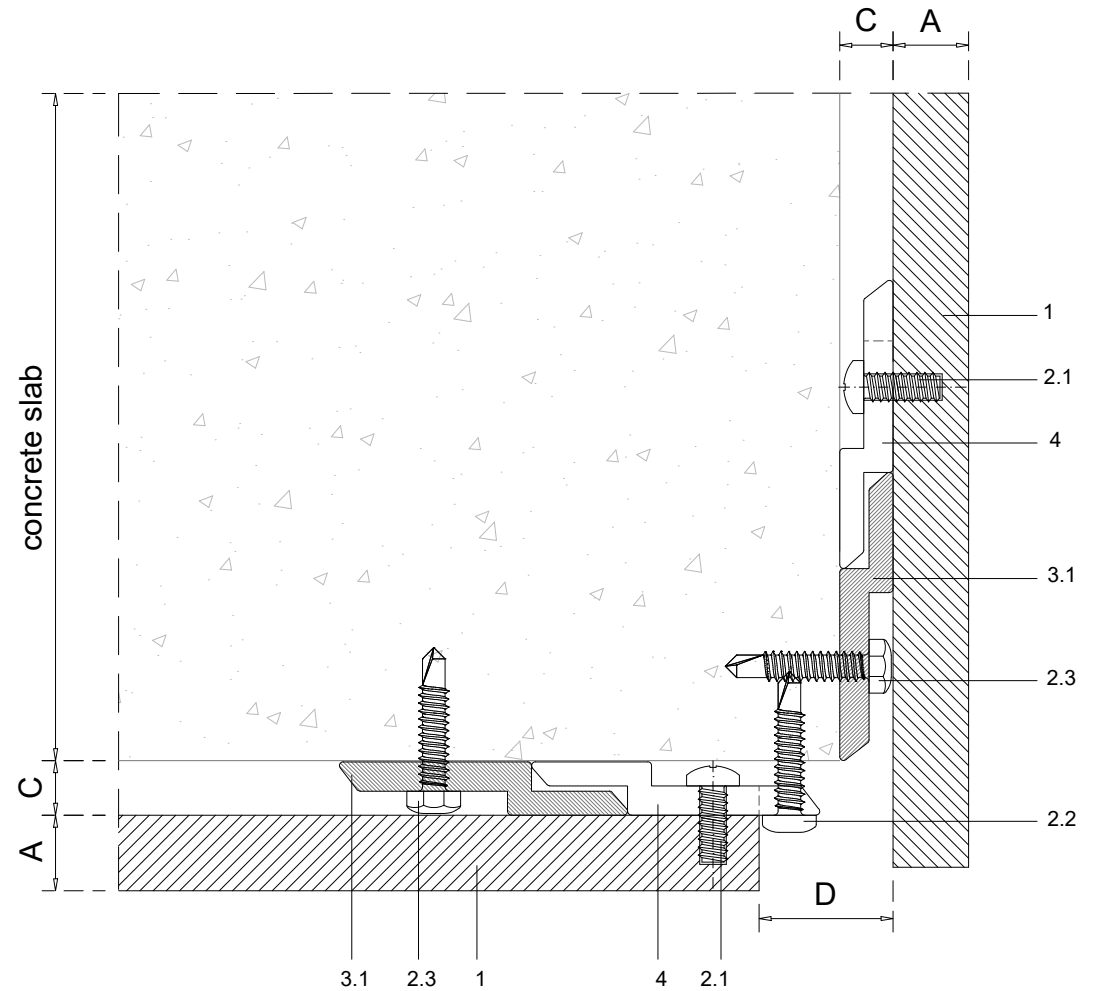
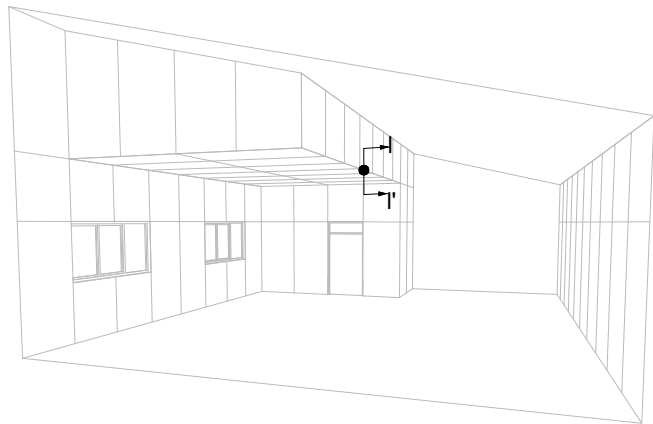

Measurements in inches are approximate. Real measurements in mm.

PARKLEX PRODEMA recommends to paint the subframe behind the panels in black when the subframe is visible through the joint.

Scale 1:1

Measures: inch

**PARKLEX PRODEMA**  
www.parklexprodema.com

PRODUCT	NATURHARDPANEL	SYSTEM	INTERIOR HANGING HOOK SYSTEM FOR WALLS AND CEILINGS	DRAWN BY	Joseba Salbide	DATE	04/2024
PLAN#	NH1-05-L	TITLE	DETAIL L-L' // CEILING/WALL INTERSECTION	APPROVED BY	Maialen Irastorza	PAGE	17 / 20

1	NATURHARDPANEL
2	Screws
2.1	Panel screw - on the rear of the panel
2.2	Clip fixing screw*
2.3	Wall fixing screw - by others
3	Profiles
3.1	Interior hanging rail
4	Interior hanging hook for walls and ceilings
6	Dropped ceiling subframe - by others

A	Panel thickness 5/16" (8mm)
B	Expansion joint 1/4" (6mm)
C	Chamber depth min. 9/32" (7mm)
D	Top expansion joint 3/4" (20mm)
E	Clip fixing screw joint (when needed) 5/16" (8mm)

\* PARKLEXPRODEMA offers fixing screw for metal and wood substrates

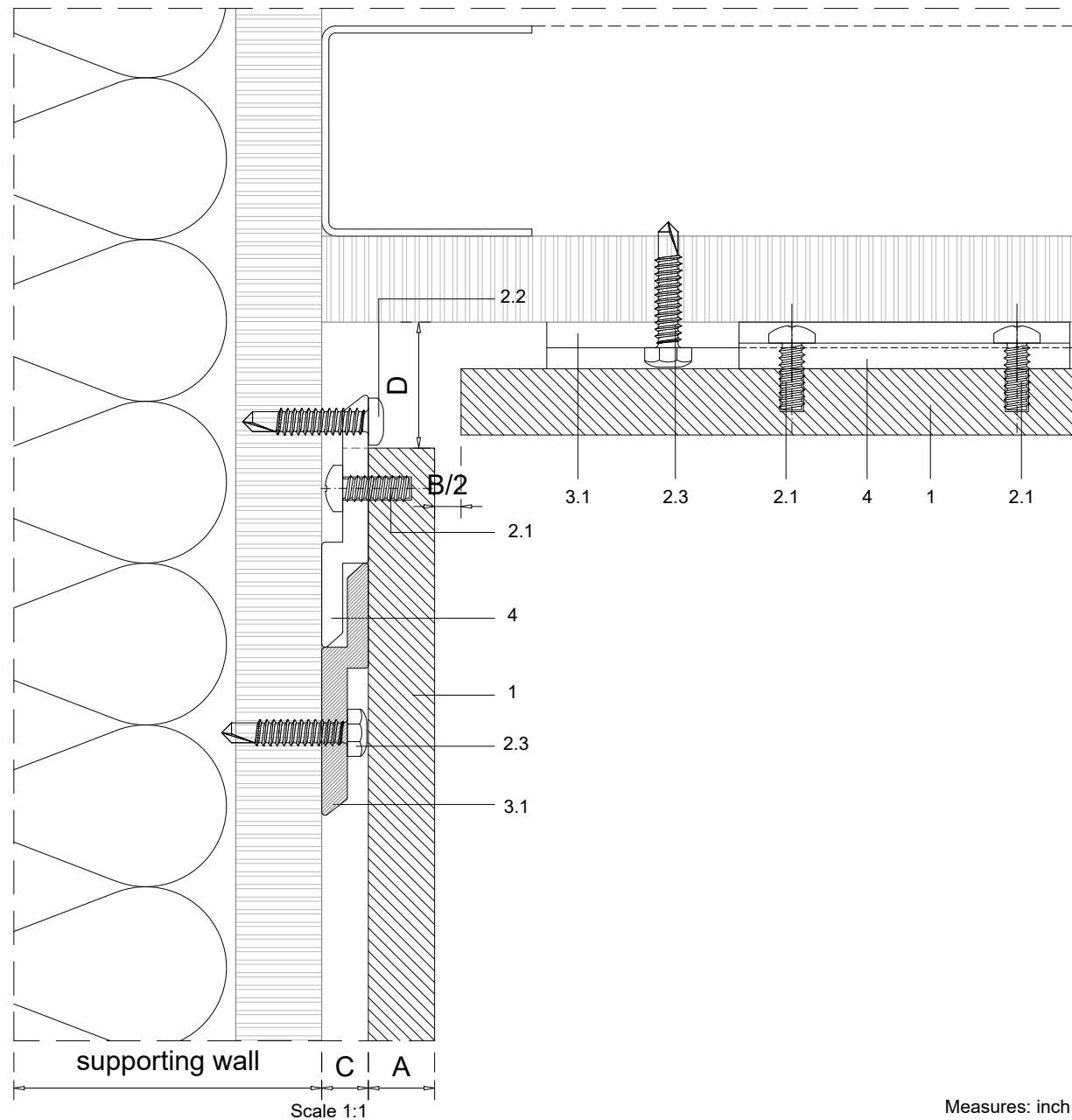
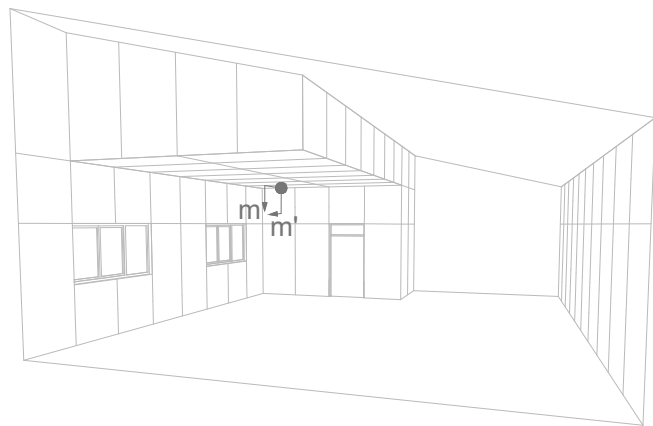

Measurements in inches are approximate. Real measurements in mm.

PARKLEX PRODEMA recommends to paint the subframe behind the panels in black when the subframe is visible through the joint.

**PARKLEX PRODEMA**  
www.parklexprodema.com

PRODUCT	NATURHARDPANEL	SYSTEM	INTERIOR HANGING HOOK SYSTEM FOR WALLS AND CEILINGS	DRAWN BY	Joseba Salbide	DATE	04/2024
PLAN#	NH1-05-M	TITLE	DETAIL M-M' // WALL/CEILING INTERSECTION	APPROVED BY	Maialen Irastorza	PAGE	18 / 20

1	NATURHARDPANEL
2	Screws
2.1	Panel screw - on the rear of the panel
2.2	Clip fixing screw*
2.3	Wall fixing screw - by others
3	Profiles
3.1	Interior hanging rail
4	Interior hanging hook for walls and ceilings
6	Dropped ceiling subframe - by others

A	Panel thickness 5/16" (8mm)
B	Expansion joint 1/4" (6mm)
C	Chamber depth min. 9/32" (7mm)
D	Top expansion joint 3/4" (20mm)
E	Clip fixing screw joint (when needed) 5/16" (8mm)

\* PARKLEXPRODEMA offers fixing screw for metal and wood substrates

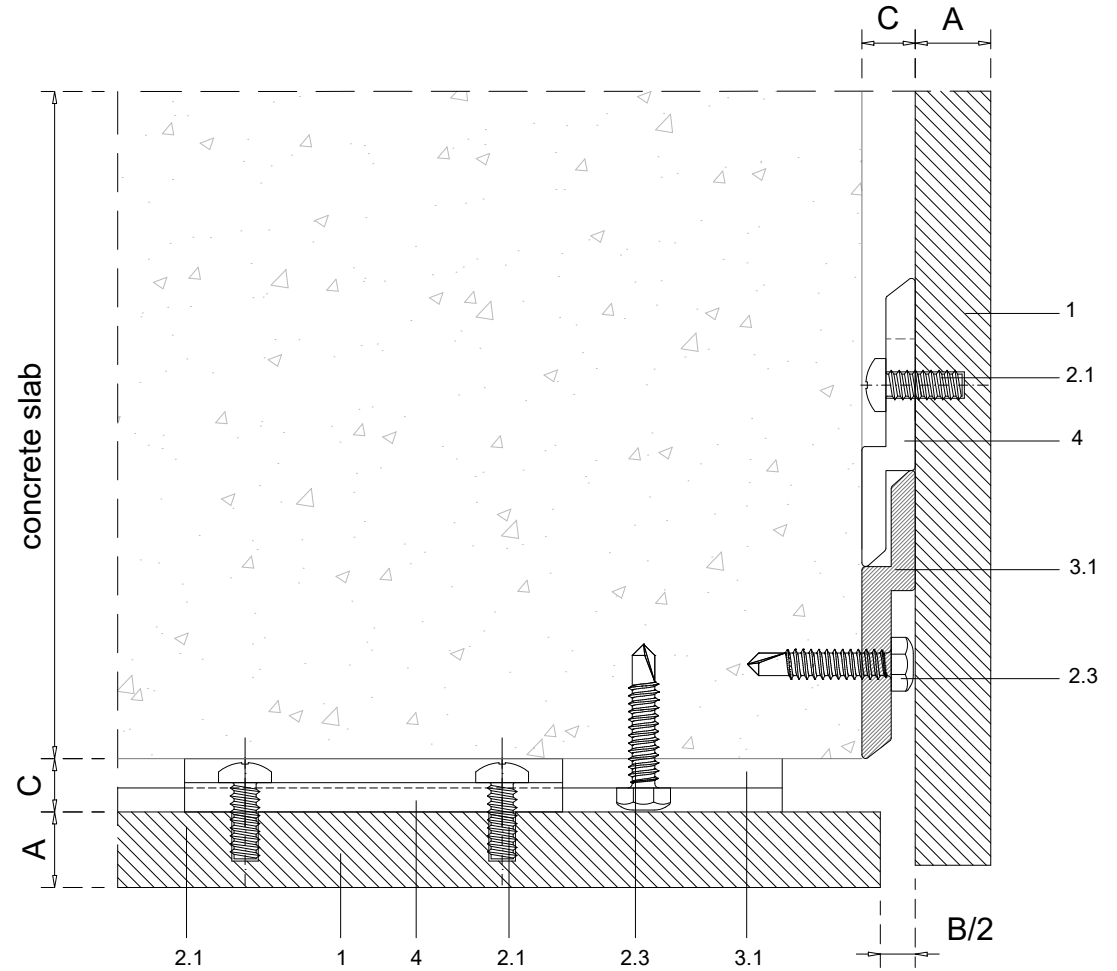
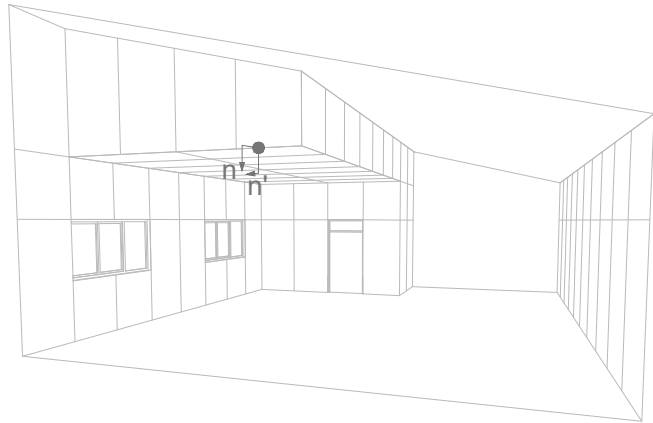

Measurements in inches are approximate. Real measurements in mm.

PARKLEX PRODEMA recommends to paint the subframe behind the panels in black when the subframe is visible through the joint.

Scale 1:1

Measures: inch

<b>PARKLEX PRODEMA</b> www.parklexprodema.com	PRODUCT	SYSTEM	DRAWN BY	DATE
	NATURHARDPANEL	INTERIOR HANGING HOOK SYSTEM FOR WALLS AND CEILINGS	Joseba Salbide	04/2024
	PLAN#	TITLE	APPROVED BY	PAGE
	NH1-05-N	DETAIL N-N' // CEILING/WALL INTERSECTION	Maialen Irastorza	19 / 20

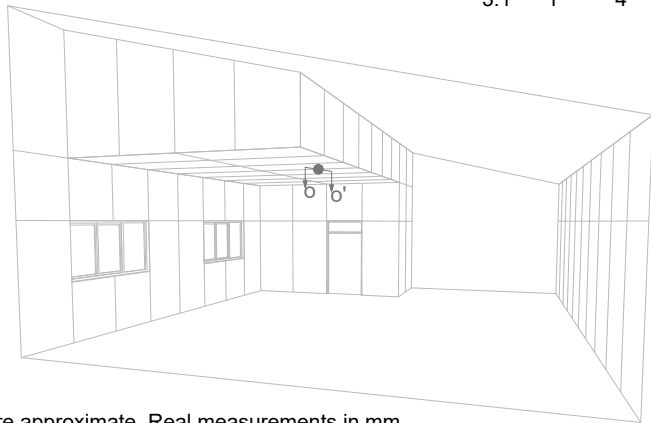
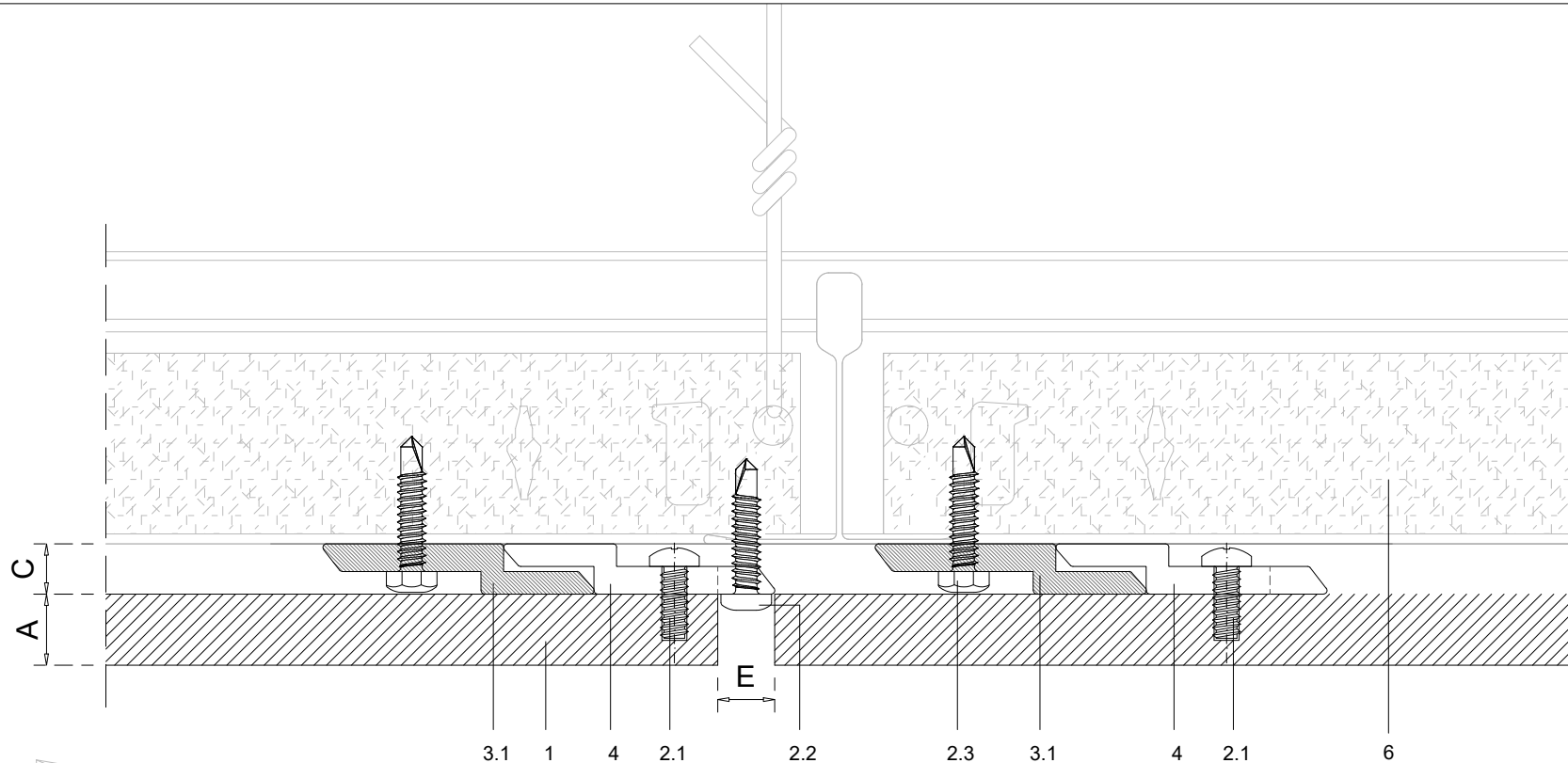

1	NATURHARDPANEL
2	Screws
2.1	Panel screw - on the rear of the panel
2.2	Clip fixing screw*
2.3	Wall fixing screw - by others
3	Profiles
3.1	Interior hanging rail
4	Interior hanging hook for walls and ceilings
6	Dropped ceiling subframe - by others
A	Panel thickness 5/16" (8mm)
B	Expansion joint 1/4" (6mm)
C	Chamber depth min. 9/32" (7mm)
D	Top expansion joint 3/4" (20mm)
E	Clip fixing screw joint (when needed) 5/16" (8mm)

\* PARKLEXPRODEMA offers fixing screw for metal and wood substrates

Measurements in inches are approximate. Real measurements in mm.

PARKLEX PRODEMA recommends to paint the subframe behind the panels in black when the subframe is visible through the joint.

Scale 1:1

Measures: inch

 www.parklexprodema.com	PRODUCT	SYSTEM	DRAWN BY	DATE
	NATURHARDPANEL	INTERIOR HANGING HOOK SYSTEM FOR WALLS AND CEILINGS	Joseba Salbide	04/2024
	PLAN#	TITLE	APPROVED BY	PAGE
	NH1-05-O	DETAIL O-O' // DROPPED CEILING	Maialen Irastorza	20 / 20