

USER MANUAL

V.3. 2025/04

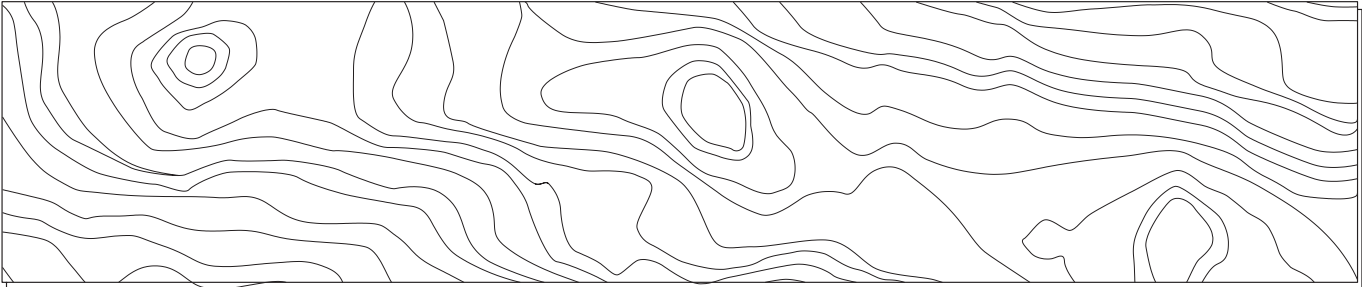
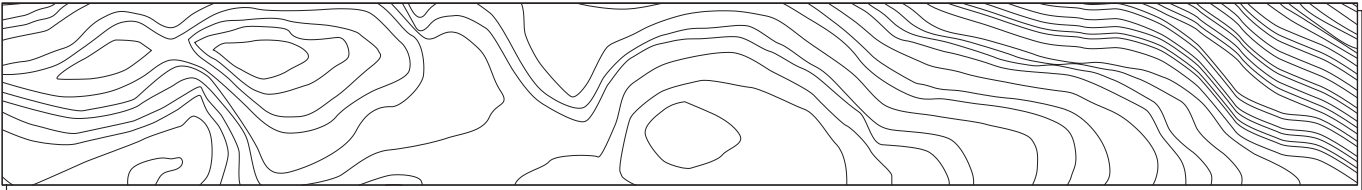

To ensure the proper use and functioning of our materials, it is essential that you thoroughly read the entire content of this document. Each page and each explanation clearly indicate the applicable product category.

If you have any questions or need further assistance, please do not hesitate to contact us at parklexprodema@parklexprodema.com. We are here to help and to ensure that your experience with our products is smooth and satisfactory.

HOW TO RECEIVE AND STORE THE MATERIAL	2
CONDITIONS BEFORE AND DURING INSTALLATION	3
HOW TO REPACKAGE THE MATERIAL	6
HOW TO CLEAN FAÇADE PANELS	7
HOW NOT TO CLEAN FAÇADE PANELS	8
HOW TO CLEAN FLOORING PANELS	9
HOW NOT TO CLEAN FLOORING PANELS	9
HOW TO CLEAN INTERIOR WALLS & CEILING PANELS	10
HOW NOT TO CLEAN INTERIOR WALLS & CEILING PANELS	10
MACHINING AND DRILLING OF THE BOARDS	11
RANDOM POSITIONING OF PANELS	14
PANELS END OF LIFE	15

HOW TO RECEIVE THE MATERIAL

PANELS FOR EXTERIORS: CLADDING, SIDING, SOFFIT

PANELS FOR INTERIORS: WALLS AND CEILINGS

PLANKS FOR INTERIOR FLOORING

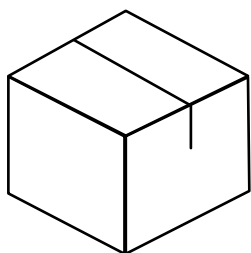

RECEPTION

ANY VISIBLE DAMAGE?

Write this down on the delivery note

ANY HIDDEN DAMAGE?

Inform of such within 72 hours

No claims will be admitted for transport reasons if any of these instructions are not followed.

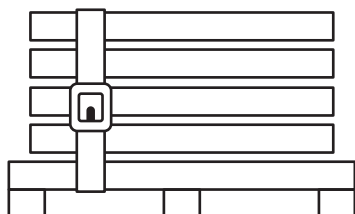

HANDLING AND STORAGE

TRANSPORT PROPERLY STRAPPED AND HORIZONTAL

The straps move up and down easily and can quickly become frayed

CONDITIONS DURING INSTALLATION

PANELS FOR EXTERIORS: CLADDING, SIDING, SOFFIT

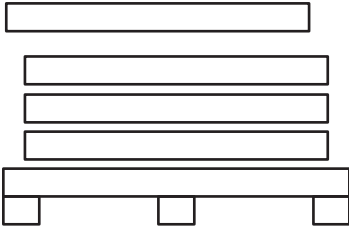

PACKAGING OPENED

ONLY TAKE OUT THE PANELS THAT ARE GOING TO BE USED IMMEDIATELY. THE REST MUST REMAIN IN STORAGE IN THE SAME CONDITIONS AS IN THE ORIGINAL PACKAGING.

KEEP THE MATERIAL PROTECTED FROM THE EFFECTS OF THE ENVIRONMENT DURING AND AFTER THESE PROCESSES. The material reacts to variations in temperature and humidity,

Facade panels are supplied with a protection film that must be removed immediately after being installed.



INSTALLATION

Each PARKLEX PRODEMA application has an installation instruction per assembly system. Request the installation instruction for the assembly system you want to use from the company's technical department, or download it from the website: www.parklexprodema.com.

PARKLEX PRODEMA will not be responsible for the use of any other assembly system that is not included in the installation instructions and/or website, except where it has given express authorisation. All installations must strictly follow the technical instructions given by the company.

Avoid installing the material in extreme climatic conditions.

The use of safety goggles and gloves during the panels' handling and cutting processes is strongly recommended. In the case of fireproof panels with fiber-glass core [GRCLAD], it is also recommended the use of mask against fine particles. Likewise, all the habitual health & safety requirements must be taken into account, as regards dust extraction and collection, fire prevention and protection measures, etc.

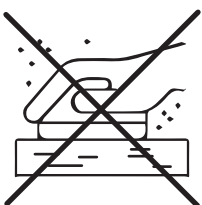

MAINTENANCE

PARKLEX PRODEMA PANELS DO NOT REQUIRE ANY MAINTENANCE. In the case of dirt, please see the cleaning section.

CONDITIONS DURING INSTALLATION

PANELS FOR INTERIORS: WALLS AND CEILINGS [1/2]



PACKAGING OPENED

ONLY TAKE OUT THE PANELS THAT ARE GOING TO BE USED IMMEDIATELY. THE REST MUST REMAIN IN STORAGE IN THE SAME CONDITIONS AS IN THE ORIGINAL PACKAGING.

Keep the material protected from the effects of the environment during and after these processes.

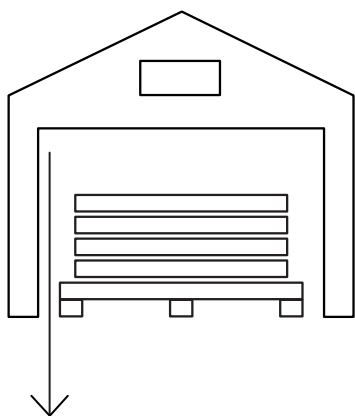

STORE INSIDE AND HORIZONTALLY

Keep them in the following conditions* for 72 hours to properly acclimate the panels to the indoor room conditions.

KEEP THE PANELS HORIZONTALLY

In the center of the room in which it is going to be installed

[15°C - 27°C / 60°F - 80°F] [40% - 65% humidity]

REMOVE THE PROTECTIVE PLASTIC THAT SURROUNDS THE PANELS

KEEP THE SUPPLIED PROTECTION BOARD ON TOP OF THE LAST TOP PANEL AT ALL TIMES

LEAVE A SEPARATION BETWEEN THE PACKAGES TO GUARANTEE A VENTILATION FLOW

The panels have to be subjected to the same humidity and temperature conditions on both sides

DO NOT SUPPORT OR STORE THE PACKAGES IN CONTACT WITH THE WALLS

Leave them at least 500mm (20") around all sides

FLOOR FREE OF ANY MATERIALS OR SUBSTANCES THAT MAY CAUSE DAMAGE

Stack the packages flat, supported by four equidistant battens or other elements that allow maintaining a distance from the ground and in which the packages are supported uniformly (pallets, etc.).

**Humidification / dehumidification systems may be necessary. If the indicated conditions are not met, deformations, cracks and in some cases even permanent damage may occur to the installed material.*



15 °C - 27°C
60°F - 80°F



40% - 65%

72 HOURS

CONDITIONS DURING INSTALLATION

PLANKS FOR INTERIOR FLOORING [2/2]



INSTALLATION

Each PARKLEX PRODEMA application has an installation instruction per assembly system. REQUEST THE INSTALLATION INSTRUCTION FOR THE ASSEMBLY SYSTEM YOU WANT TO USE FROM THE COMPANY'S TECHNICAL DEPARTMENT, OR DOWNLOAD IT FROM THE WEBSITE:

www.parklexprodema.com.

PARKLEX PRODEMA will not be responsible for the use of any other assembly system that is not included in the installation instructions and/or website, except where it has given express authorisation. All installations must strictly follow the technical instructions given by the company.

The use of safety goggles and gloves during the slats' handling and cutting processes is strongly recommended. Likewise, all the habitual health & safety requirements must be taken into account, as regards dust extraction and collection, fire prevention and protection measures, etc.

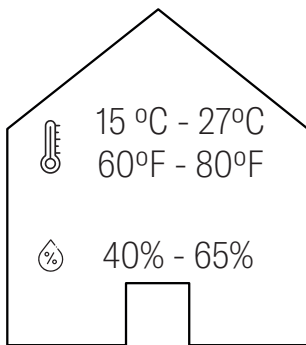

THE TEMPERATURE AND HUMIDITY CONDITIONS OF BOTH THE ENCLOSURE AND THE MATERIAL ARE CRITICAL BEFORE AND DURING THE INSTALLATION PROCESS.

The conditions in the room during the life of the product must be at a TEMPERATURE BETWEEN 15°C – 27°C AND A RELATIVE HUMIDITY BETWEEN 40 – 65%. To achieve these conditions, humidification / dehumidification systems may be necessary.

To avoid any weather-related damage, the building must be properly enclosed. Any work that introduces moisture to the site must be completed before the material is installed. In the case of installing interior floor planks with radiant heating, refer to the recommendations in the installation instructions.

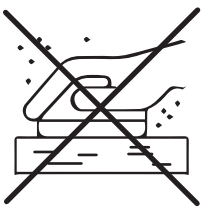

MAINTENANCE

PARKLEX PRODEMA PLANKS DO NOT REQUIRE ANY MAINTENANCE.

In the case of dirt, please see the cleaning section.

Protect planks from direct sunlight.

When moving heavy furniture, it should be lifted and not pushed.

In case of using casters for chairs and furniture, only soft type casters should be used.

Always use special wheels for wooden floors.

You must protect the legs of chairs and tables with a self-adhesive felt protector.

In uses in which the surface of the floor directly limits with the outside, a clean transit area (mat type) of adequate dimensions must be incorporated.

If the indicated conditions are not met, deformations, cracks and in some cases even permanent damage may occur to the installed material.

HOW TO REPACKAGE THE MATERIAL

PANELS FOR EXTERIORS: CLADDING, SIDING, SOFFIT

PANELS FOR INTERIORS: WALLS AND CEILINGS

PLANKS FOR INTERIOR FLOORING

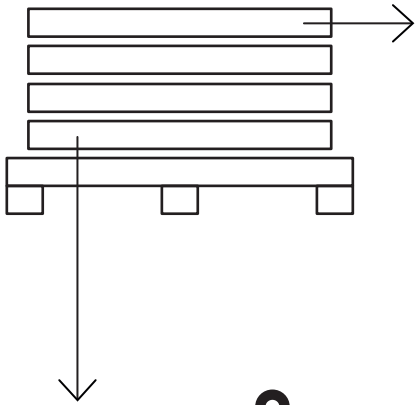

THE PANELS AND PLANKS MUST BE INSIDE THE PACKAGE UNTIL THEY ARE INSTALLED IN SITE. If the client needs to handle the material for precuts or predrilling, and the package needs to be opened beforehand, it is highly important to keep the material protected to the environment effects during and after these processes. The material reacts to the humidity and temperature variations.

REPACKAGING

0. A TOP BOARD ensures flatness of the panels at the top
1. ALUMINUM SHEET prevents first panel/plank from humidity variations
2. PARKLEX PRODEMA PANELS / PLANKS
3. ALUMINUM SHEET prevents last panel/plank from humidity variations
4. A BASE BOARD gives a flat support

PLACE ANOTHER PALET NEXT TO THE ONE SENT BY PARKLEX PRODEMA

This new palet must have at the base a flat board (4), an aluminum sheet at the base (3), similar to the one used on the original package.

THE PANELS/PLANKS FROM THE FIRST PALET MUST BE COVERED

with the aluminum sheet (1) and a board at the top (0) while the material is being cut.

PLACE THE CUT AND PREDRILLED PIECES ONE ON TOP OF THE OTHER

Make sure every panel/plank is placed on a flat surface. The waste material can be used to do a proper strapping.

PLACE AT THE TOP THE ALUMINUM SHEET (1) AND A BOARD (0)

after stacking the material

PLACE ON THE SIDES EDGE BOARDS AND COVER THE WHOLE PALET WITH A PLASTIC FILM

STRAP THE WHOLE PACKAGE

The packaging is made up of three different materials: cardboard, wood and plastic, which can be easily separated and recycled.

HOW TO CLEAN FAÇADE PANELS

DIRT DOES NOT STICK EASILY TO THE SURFACE

Carry out a cleaning test on a small area of the material, in order to verify the effectiveness of the procedure, and only then proceed with the entire surface.



the recommended cleaning method

CLEANING WITH WATER AND DETERGENT

Diluted household detergents and cleaners can be used.

Follow at all times the recommendations of the manufacturer of the cleaning product on its dilution in water, especially in the case of concentrated products.

The use of solvents and chemical cleaning products must always be carried out respecting the corresponding safety and hygiene rules.

To remove traces of paint, ink, cement, plaster or any other type of persistent stain, consult the PARKLEX PRODEMA Technical Department



PRESSURE WASHER CLEANING

Suitable method as long as it is applied with caution.

Maximum recommended pressure is 1500 psi (103 bars)

Distance of no less than 30 cm



FLUFF-FREE CLOTHS | BRUSHES WITH BRISTLES OF MEDIUM HARDNESS

IMPORTANT

Remove immediately the protection film of the panel after being installed.

If the surface gets dirty or there is any adhesive residue left from the protective film, it can be cleaned with lukewarm water mixed with liquid detergent using a soft cloth. If the dirt persists, use WD40 spray or isopropyl alcohol. After using these products, clean the surface of the panel using a soft cloth with warm water and liquid detergent.

Never dry rub the surface.

Never use abrasive detergents

To clean adhesive residue on the surface of the panel, check the supplier's cleaning instructions, as long as these instructions do not interfere with those recommended by PARKLEX PRODEMA

Convey these recommendations to the party responsible for maintenance throughout the building's lifespan.

There is a list of commercial products that can be used and that should be avoided.

For more details, consult the PARKLEX PRODEMA Technical Department.

HOW NOT TO CLEAN FAÇADE PANELS

DO NOT USE THESE CLEANING METHODS



do not

CLEAN FAÇADE PANELS ON HOT DAYS OR IN FULL SUN

At high temperatures the cleaning products can become more aggressive and damage the surface.
Never let the cleaner dry or evaporate before rinsing it off with water.



do not use

CLEANING SYSTEMS THAT INVOLVE EXTERNAL SOURCES OF HEAT such as hot spatulas or hot air guns.



do not use

STEAM CLEANERS



do not use

SPONGES OR CLOTHS WITH ABRASIVE CLEANING AGENTS OR SCOURERS, as they can damage the product's surface



prohibited products

SOME VERY AGGRESSIVE SOLVENTS AND CLEANING PRODUCTS DETERGENTS WITH ABRASIVE PARTICLES
These could cause permanent damage to their surface, dissolving it, whitening it or producing small cracks that may not be evident at first sight.



do not use

CHEMICAL PRODUCTS FOR CLEANING, TREATING OR PROTECTING WOOD

INDUSTRIAL CLEANING PRODUCTS, BLEACHES OR CONCENTRATED HOUSEHOLD PRODUCTS UNDILUTED ACCORDING TO THE MANUFACTURER'S RECOMMENDATIONS

UNIVERSAL SOLVENTS OR PETROLEUM ETHER (PETROLEUM NAPHTA)

Usually formed by mixtures of various solvents

CLEANING PRODUCTS ("CLEANERS") AND/OR ADHESION PROMOTERS USED IN ADHESIVE FIXING SYSTEMS.
These products CAN be used on the reverse side of the panels but NOT in the face view

AROMATIC TYPE SOLVENTS such as Benzene, Toluene or Xylene, or mixtures that may contain them.

KETONE-TYPE SOLVENTS such as Acetone (Propanone) or Methyl-ethyl-ketone (MEC), or mixtures that may contain them.

ETHYL ACETATE or mixtures that may contain it.

HOW TO CLEAN FLOORING PLANKS

DIRT DOES NOT STICK EASILY TO THE SURFACE

Carry out a cleaning test on a small area of the material, in order to verify the effectiveness of the procedure, and only then proceed with the entire surface.



the recommended cleaning method

LUKEWARM WATER MIXED WITH NON-ABRASIVE (PH NEUTRAL) HOUSEHOLD DETERGENT

Follow at all times the recommendations of the manufacturer of the cleaning product.



USE A DAMP, SMOOTH MOP OR SPONGE AND NEVER RUB THE SURFACE DRY

First vacuum the surface to remove loose dust/solid particles



FOR PERSISTENT STAINS, USE CONVENTIONAL COMMERCIAL BLEACHES

Always diluted in the concentrations recommended by the manufacturer

HOW NOT TO CLEAN FLOORING PLANKS

DO NOT USE THESE CLEANING METHODS



do not use

SPONGES, PAPERS OR CLOTHS WITH ABRASIVE CLEANING AGENTS

Scotch Brite or sandpaper, should never be used as they can damage the surface



prohibited products

DETERGENTS CONTAINING ABRASIVE PARTICLES

These could cause permanent damage to their surface, dissolving it, whitening it or producing small cracks that may not be evident at first sight.



do not use

EXCESS WATER, OR LEAVE PUDDLES OF WATER ON THE FLOOR.

A damp mop/sponge is sufficient to remove most stains.



do not

CLEAN WITH PRESSURIZED WATER MACHINES

The use of solvents and chemical cleaning products must always be carried out respecting the corresponding safety and hygiene rules.

To clean adhesive residue on the surface of the plank, check the supplier's cleaning instructions, as long as these instructions do not interfere with those recommended by PARKLEX PRODEMA.

Convey these recommendations to the party responsible for maintenance throughout the building's lifespan.

*There is a list of commercial products that can be used and that should be avoided.
For more details, consult the PARKLEX PRODEMA Technical Department.*

HOW TO CLEAN INTERIOR WALLS & CEILING PANELS

DIRT DOES NOT STICK EASILY TO THE SURFACE

Carry out a cleaning test on a small area of the material, in order to verify the effectiveness of the procedure, and only then proceed with the entire surface.



the recommended cleaning method

LUKEWARM WATER MIXED WITH LIQUID DETERGENT

Follow at all times the recommendations of the manufacturer of the cleaning product.



USE A SOFT CLOTH AND NEVER RUB THE SURFACE DRY



FOR PERSISTENT STAINS, USE CONVENTIONAL COMMERCIAL BLEACHES

Always diluted in the concentrations recommended by the manufacturer

HOW NOT TO CLEAN INTERIOR WALLS & CEILING PANELS

DO NOT USE THESE CLEANING METHODS



do not use

SPONGES, PAPERS OR CLOTHS WITH ABRASIVE CLEANING AGENTS

Scotch Brite or sandpaper, should never be used as they can damage the surface



prohibited products

DETERGENTS CONTAINING ABRASIVE PARTICLES

These could cause permanent damage to their surface, dissolving it, whitening it or producing small cracks that may not be evident at first sight.



do not

CLEAN WITH PRESSURIZED WATER MACHINES

The use of solvents and chemical cleaning products must always be carried out respecting the corresponding safety and hygiene rules. Convey these recommendations to the party responsible for maintenance throughout the building's lifespan.

To clean adhesive residue on the surface of the panel, check the supplier's cleaning instructions, as long as these instructions do not interfere with those recommended by PARKLEX PRODEMA.

There is a list of commercial products that can be used and that should be avoided. For more details, consult the PARKLEX PRODEMA Technical Department.

MACHINING AND DRILLING OF THE BOARDS [1/3]

Due to their composition, the PARKLEX PRODEMA panels and planks are relatively hard. The tools used for cutting the boards must be more resistant than those used for most woods or wood-based materials.

TOOLS TO CUT THE BOARDS

Panels need to be squared before cutting begins.

Tools made of hardness material K-05 and K-01

- _ well-sharpened
- _ avoiding overheating

INTERIOR PANELING AND FAÇADE

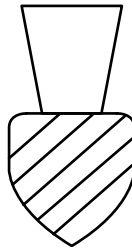

polycrystalline diamond | pcd

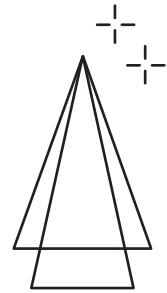

tungsten carbide | widia

FLOORING

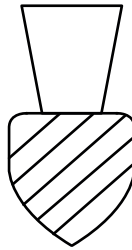

polycrystalline diamond | pcd

For more details, consult the PARKLEX PRODEMA Technical Department.

MACHINING AND DRILLING OF THE BOARDS [2/3]

Due to their composition, the PARKLEX PRODEMA panels and planks are relatively hard. The tools used for cutting the boards must be more resistant than those used for most woods or wood-based materials.

PARAMETERS FOR SAW BLADES ACCORDING TO TOOL TYPE

	Blade diameter	Teeth (z)	Speed (rpm)	Blade thickness	Types of tooth
Static circular saw	300 mm (12") 250 mm (10")	80	4000 - 6000	3.2 mm (1/8")	Flat, trapeze, alternate and all their combinations
Manual circular saw	190 mm (7.5")	30	3000 - 3500	2.2 mm (3/32")	

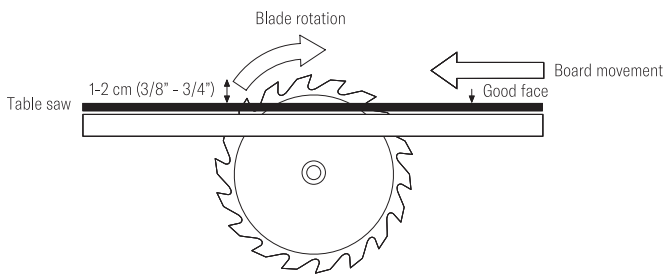

The cutting tool must be perfectly sharpened or it could cause splintering on the sides. The saw blade must always begin cutting on the front side (face) of the panel/plank. Using the table saw, the front face of the panel/plank must be facing up and in case of the manual saw, the front face of the panel/plank must be facing down. In order to obtain a clean cut, it is recommended to keep the height of the blade 1-2 cm (3/8"-3/4") above the panel/plank face.

DRILLING RECOMMENDATIONS

The panels must be drilled using hard metal or "Widia" tools, and the planks using a pcd tool, with a cutting angle greater than 100°. Supporting sheets (martyr boards) must be used under the panel/plank in order to drill a clean hole, without 'breakout'.

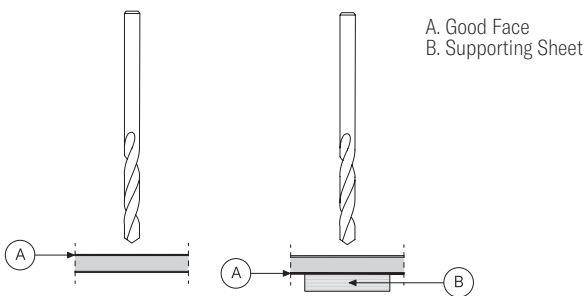

MACHINING RECOMMENDATIONS

WATER JET CUT

This system is compatible with PARKLEX PRODEMA panels/planks, although it is advisable to carry out a preliminary test in order to adjust the parameters.

LASER CUT

This system is not recommended for PARKLEX PRODEMA panels/planks given that it blackens and burns the wood veneer.

CNC

The PARKLEX PRODEMA panels/planks can be machined on CNC machining centers. The milling bits must be perfectly sharp, with the following recommendations:

Turning speed = 16,000 rpm

Movement speed = 4 m/min (13'/min)

After fabrication (cutting, drilling, sanding of edges, if needed), no other treatment for finishing or protecting is required.

Rough edges may be smoothed out with sand paper.

MACHINING AND DRILLING OF THE BOARDS [3/3]

Due to their composition, the PARKLEX PRODEMA panels/planks are relatively hard. The tools used for cutting the boards must be more resistant than those used for most woods or wood-based materials.

SAFETY MEASURES

To ensure personnel protection and minimize risks during operations, it is essential to follow the following safety measures. Proper use of personal protective equipment will help prevent accidents and health hazards.

- Have a particle extraction system in place*
- Wear cut-resistant safety gloves
- Wear long pants and a long-sleeved shirt to avoid skin contact*
- Use dust masks
- Wear safety glasses

*Especially in the case of fireproof panels with fiber-glass core [GRCLAD]

RANDOM POSITIONING OF PANELS/PLANKS

PARKLEX PRODEMA panels/planks are manufactured with natural wood and therefore will exhibit variations. Prior to fabrication and installation, it is recommended to mix panels/planks to achieve an even distribution of knots throughout the cladding.

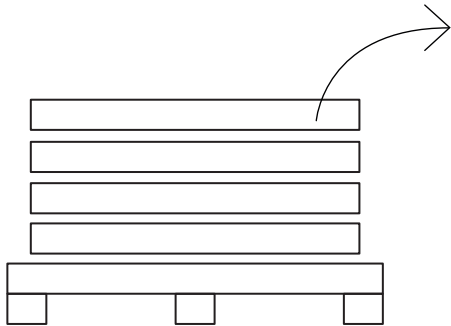

1 - Number all the pallets 1, 2, 3, etc.

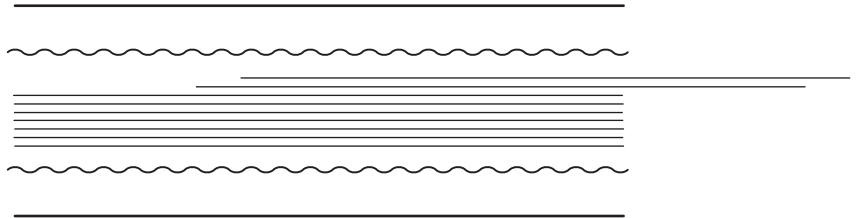

2 - Open pallet number 1 and remove two panels/planks. Place these two panels/planks on a flat pallet, with a maximum distance of 800 mm (32") between supports.

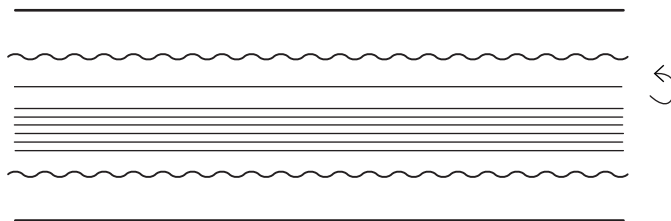

3 - Turn over the third panel/plank from pallet number 1 without removing it from the pallet.

4 - Close pallet number 1 and store it respecting the packaging conditions.

5 - Repeat the same process with the other pallets, selecting them in a random order until 10 to 20 panels/planks have been removed. For example, if there are 20 pallets, remove panels/planks from numbers 1, 8, 13, 15 and 20, or other random order.

6 - Mix 10 to 20 panels/planks that have been removed and install them within 2 to 3 hours from the time first panel/plank was removed.

7 - Repeat the first six steps until all the panels/planks have been installed.

Natural wood will always show variations from panel to panel, plank to plank. This variation is more obvious when installing large size panels/planks. However, the difference will be minimized when smaller size panels/planks are used. If you wish to see less color variance, a control sample must be sent with material order. We will then do our best to produce panels/planks that are more homogeneous in color, although there will always be variations.

PANELS END OF LIFE

Natural wood is a delicate material. There is no established method for repairing PARKLEX PRODEMA panels or planks. Damaged panels and planks must be replaced with new ones.

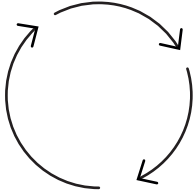

REUSE

The reuse of PARKLEX PRODEMA panels/planks will be encouraged in other applications with different requirements.

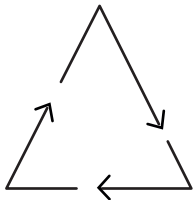

RECYCLE

The cellulose fibers in the core and the thermoset wood veneer can be recycled. The recycling possibilities include use as filling material in wood-based panels/planks for the construction industry.



LANDFILL OR DUMPING

All specifications controlling the production and management of construction and demolition waste will be followed, as well as any local regulations that may apply. It might also be utilized in industrial incinerators.

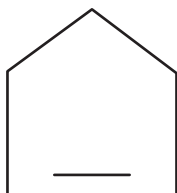

SUB-STRUCTURE

The wooden, aluminum or steel profiles can be directly reused for their original application or recycled if the buildings are carefully deconstructed.

WWW.PARKLEXPRODEMA.COM

HOW TO RECEIVE AND STORE THE MATERIAL

PANELS FOR EXTERIORS: CLADDING, SIDING, SOFFIT

PANELS FOR INTERIORS: WALLS AND CEILINGS

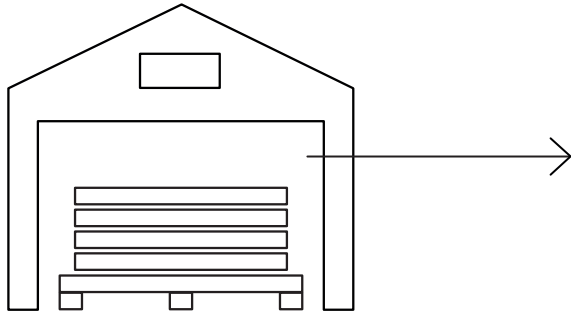

10 °C - 27°C
50°F - 80°F

30% - 70%

STORE INSIDE AND HORIZONTALLY

WITH A DISTANCE BETWEEN SUPPORTS < 800 mm

Panels that have fastening or fixing elements attached must be stored in a front against front, back against back pattern, using intermediate wooden or plastic supports placed at a distance of up to < 800 mm between supports.

IN A CLOSED, VENTILATED AREA, IN THEIR ORIGINAL PACKAGING

Sheltered from the weather and extremes of temperature.

DO NOT SUPPORT OR STORE THE PACKAGES IN CONTACT WITH THE WALLS

Leave them at least 500mm (20") around all sides

LEAVE A SEPARATION BETWEEN THE PACKAGES TO GUARANTEE A VENTILATION FLOW

The panels have to be subjected to the same humidity and temperature conditions on both sides

FLOOR FREE OF ANY MATERIALS OR SUBSTANCES THAT MAY CAUSE DAMAGE

Improper storage / handling of the panels can cause permanent deformation in the panels.

Follow manufacturer's repackaging instructions.

HOW TO RECEIVE AND STORE THE MATERIAL

PLANKS FOR INTERIOR FLOORING

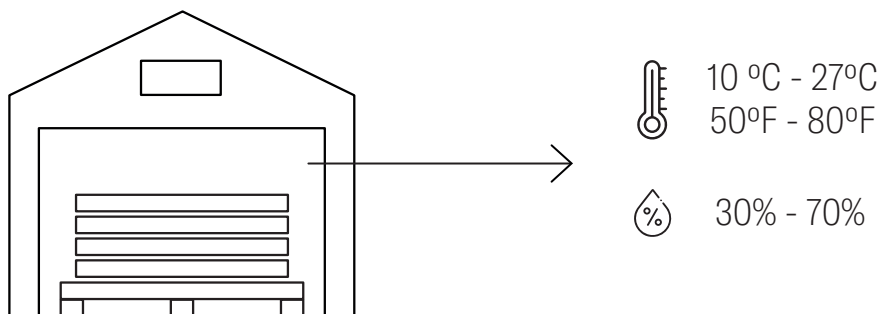

STORE INSIDE AND HORIZONTALLY

WITH A DISTANCE BETWEEN SUPPORTS < 800 mm

IN A CLOSED, VENTILATED AREA, IN THEIR ORIGINAL PACKAGING

Sheltered from the weather and extremes of temperature.

DO NOT SUPPORT OR STORE THE PACKAGES IN CONTACT WITH THE WALLS

Leave them at least 500mm (20") around all sides

LEAVE A SEPARATION OF 500MM BETWEEN THE PACKAGES TO GUARANTEE A VENTILATION FLOW

Leave a gap between the packages to ensure proper airflow.

The planks have to be subjected to the same humidity and temperature conditions on both sides.

FLOOR FREE OF ANY MATERIALS OR SUBSTANCES THAT MAY CAUSE DAMAGE

Improper storage / handling of the planks can cause permanent deformation in the planks.

Follow manufacturer's repackaging instructions

IMPORTANT: For flooring planks in the USA, an absolute minimum of 5 days as per the NWFA prior to fitting.

CONDITIONS DURING INSTALLATION

PLANKS FOR INTERIOR FLOORING [1/2]



PACKAGING OPENED

ONLY TAKE OUT THE PLANKS THAT ARE GOING TO BE USED IMMEDIATELY. THE REST MUST REMAIN IN STORAGE IN THE SAME CONDITIONS AS IN THE ORIGINAL PACKAGING.

Keep the material protected from the effects of the environment during and after these processes.

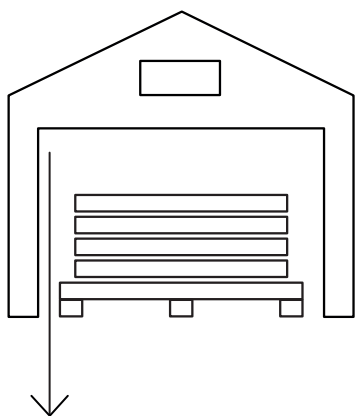

STORE INSIDE AND HORIZONTALLY

Keep them in the following conditions* for 72 hours to properly acclimate the planks to the indoor room conditions:

KEEP THE PLANKS HORIZONTALLY

In the center of the room in which it is going to be installed

[15°C - 27°C / 60°F - 80°F] [40% - 65% humidity]

REMOVE THE PROTECTIVE PLASTIC THAT SURROUNDS THE PLANKS

KEEP THE SUPPLIED PROTECTION BOARD ON TOP OF THE LAST TOP PANEL AT ALL TIMES

LEAVE A SEPARATION BETWEEN THE PACKAGES TO GUARANTEE A VENTILATION FLOW

The planks have to be subjected to the same humidity and temperature conditions on both sides

DO NOT SUPPORT OR STORE THE PACKAGES IN CONTACT WITH THE WALLS

Leave them at least 500mm (20") around all sides

FLOOR FREE OF ANY MATERIALS OR SUBSTANCES THAT MAY CAUSE DAMAGE

Stack the packages flat, supported by four equidistant battens or other elements that allow maintaining a distance from the ground and in which the packages are supported uniformly (pallets, etc.).

**Humidification / dehumidification systems may be necessary. If the indicated conditions are not met, deformations, cracks and in some cases even permanent damage may occur to the installed material.*

important:

For flooring planks in the USA, an absolute minimum of 5 days as per the NWFA prior to fitting.

 15 °C - 27°C
60°F - 80°F

 40% - 65%

72 HOURS

CONDITIONS DURING INSTALLATION

PANELS FOR INTERIORS: WALLS AND CEILINGS [2/2]



INSTALLATION

Each PARKLEX PRODEMA application has an installation instruction per assembly system. Request the installation instruction for the assembly system you want to use from the company's technical department, or download it from the website:

www.parklexprodema.com.

PARKLEX PRODEMA will not be responsible for the use of any other assembly system that is not included in the installation instructions and/or website, except where it has given express authorisation. All installations must strictly follow the technical instructions given by the company.

The use of safety goggles and gloves during the panels' handling and cutting processes is strongly recommended. Likewise, all the habitual health & safety requirements must be taken into account, as regards dust extraction and collection, fire prevention and protection measures, etc.

THE TEMPERATURE AND HUMIDITY CONDITIONS OF BOTH THE ENCLOSURE AND THE MATERIAL ARE CRITICAL BEFORE AND DURING THE INSTALLATION PROCESS. The conditions in the room during the life of the product must be at A TEMPERATURE BETWEEN 15°C – 27°C AND A RELATIVE HUMIDITY BETWEEN 40 – 65%. To achieve these conditions, humidification / dehumidification systems may be necessary.

To avoid any weather-related damage, the building must be properly enclosed. Any work that introduces moisture to the site must be completed before the material is installed. Protect panels from direct sunlight.

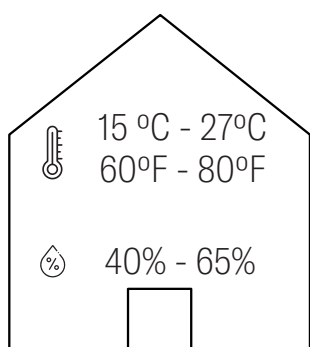

MAINTENANCE

PARKLEX PRODEMA PANELS DO NOT REQUIRE ANY MAINTENANCE.

In the case of dirt, please see the cleaning section.

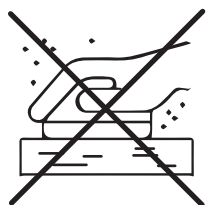

If the indicated conditions are not met, deformations, cracks and in some cases even permanent damage may occur to the installed material.